

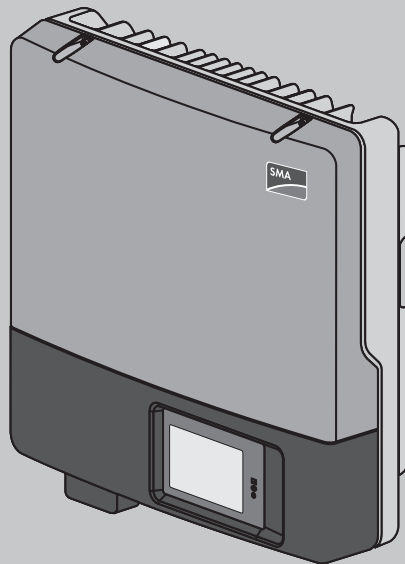

Operating Manual

SUNNY BOY 3000TL / 3600TL / 4000TL / 5000TL



Legal Provisions

The information contained in these documents is property of SMA Solar Technology AG. Any publication, whether in whole or in part, requires prior written approval by SMA Solar Technology AG. Internal reproduction used solely for the purpose of product evaluation or other proper use is allowed and does not require prior approval.

SMA Warranty

You can download the current warranty conditions from the Internet at www.SMA-Solar.com.

Trademarks

All trademarks are recognized, even if not explicitly identified as such. A lack of identification does not mean that a product or symbol is not trademarked.

The BLUETOOTH® word mark and logos are registered trademarks of Bluetooth SIG, Inc. and any use of these marks by SMA Solar Technology AG is under license.

Modbus® is a registered trademark of Schneider Electric and is licensed by the Modbus Organization, Inc.

QR Code is a registered trademark of DENSO WAVE INCORPORATED.

Phillips® and Pozidriv® are registered trademarks of Phillips Screw Company.

Torx® is a registered trademark of Acument Global Technologies, Inc.

SMA Solar Technology AG

Sonnenallee 1

34266 Niestetal

Germany

Tel. +49 561 9522-0

Fax +49 561 9522-100

www.SMA.de

E-mail: info@SMA.de

© 2004 to 2014 SMA Solar Technology AG. All rights reserved.

Table of Contents

1	Information on this Document	6
1.1	Validity	6
1.2	Target Group.....	6
1.3	Additional Information	6
1.4	Symbols	7
1.5	Nomenclature.....	7
2	Safety	9
2.1	Intended Use	9
2.2	Safety Information.....	9
3	Scope of Delivery.....	11
4	Product Description.....	12
4.1	Sunny Boy.....	12
4.2	Interfaces and Functions	15
5	Mounting	17
5.1	Requirements for Mounting	17
5.2	Mounting the Inverter.....	19
6	Electrical Connection.....	21
6.1	Safety during Electrical Connection.....	21
6.2	Overview of the Connection Area	22
6.2.1	View from Below	22
6.2.2	Interior View	23
6.3	AC Connection.....	24
6.3.1	Requirements for the AC Connection.....	24
6.3.2	Connecting the Inverter to the Utility Grid.....	25
6.3.3	Connecting Additional Grounding	27
6.4	DC Connection.....	27
6.4.1	Requirements for the DC Connection.....	27
6.4.2	Connecting the PV Array	28
7	Commissioning.....	31
7.1	Commissioning Procedure	31

7.2	Configuring the Country Data Set.....	31
7.3	Setting the NetID.....	32
7.4	Commissioning the Inverter.....	34
7.5	Self-Test in Accordance with CEI 0-21 for PV Systems ≤ 6 kW	35
7.5.1	Starting the Self-Test.....	35
7.5.2	Restarting the Self-Test	36
8	Configuration	38
8.1	Configuration Procedure.....	38
8.2	Changing the Display Language	38
8.3	Integrating the Inverter into the Network.....	39
8.4	Changing Operating Parameters.....	39
8.5	Deactivating Grounding Conductor Monitoring.....	40
8.6	Setting SMA OptiTrac Global Peak	40
9	Operation	41
9.1	LED Signals.....	41
9.2	Display Overview.....	41
9.3	Activating and Operating the Display	44
9.4	Calling Up Display Messages of the Start-Up Phase	44
10	Disconnecting the Inverter from Voltage Sources.....	45
11	Technical Data.....	47
11.1	DC/AC	47
11.1.1	Sunny Boy 3000TL / 3600TL.....	47
11.1.2	Sunny Boy 4000TL / 5000TL.....	48
11.2	General Data	50
11.3	Protective Devices	51
11.4	Climatic Conditions	52
11.5	Equipment.....	52
11.6	Torques	52
11.7	Electronic Solar Switch	53
11.8	Data Storage Capacity.....	53
12	Accessories	54

13 Contact.....	55
14 EC Declaration of Conformity	58

1 Information on this Document

1.1 Validity

This document is valid for the following device types from firmware version 2.55:

- SB 3000TL-21 (Sunny Boy 3000TL)
- SB 3600TL-21 (Sunny Boy 3600TL)
- SB 4000TL-21 (Sunny Boy 4000TL)
- SB 5000TL-21 (Sunny Boy 5000TL)

1.2 Target Group

This document is intended for qualified persons and end users. Only qualified persons are allowed to perform the activities marked in this document with a warning symbol and the caption "Qualified person". Tasks that do not require any particular qualification are not marked and can also be performed by end users. Qualified persons must have the following skills:

- Knowledge of how an inverter works and is operated
- Training in how to deal with the dangers and risks associated with installing and using electrical devices and installations
- Training in the installation and commissioning of electrical devices and installations
- Knowledge of the applicable standards and directives
- Knowledge of and compliance with this document and all safety information







1.3 Additional Information

Links to additional information can be found at www.SMA-Solar.com:

Document title and content	Document type
Troubleshooting, Cleaning, Replacement of Varistors and Decommissioning	Service Manual
"Overview of the Rotary Switch Settings" Overview of the rotary switch settings for configuring the country data set and display language	Technical Information
"Efficiency and Derating" Efficiency and Derating Behavior of the Sunny Boy, Sunny Tripower and Sunny Mini Central Inverters	Technical Information
"Criteria for Selecting a Residual-Current Device"	Technical Information
"Circuit Breaker" Dimensioning and Selection of a Suitable AC Circuit Breaker for Inverters under PV-Specific Influences	Technical Information

Document title and content	Document type
"Insulation Resistance (Riso) of Non-Galvanically Isolated PV Systems"	Technical Information
"Integrated Plant Control and Q on Demand 24/7" Detailed explanation of functions and description for setting the functions	Technical Information
"Webconnect Systems in Sunny Portal" Registration in Sunny Portal	User Manual
"Firmware Update with SD Card"	Technical Description
"Parameter list" Overview of All Inverter Operating Parameters and Their Configuration Options	Technical Information

1.4 Symbols

Symbol	Explanation
	Indicates a hazardous situation which, if not avoided, will result in death or serious injury
	Indicates a hazardous situation which, if not avoided, can result in death or serious injury
	Indicates a hazardous situation which, if not avoided, can result in minor or moderate injury
	Indicates a situation which, if not avoided, can result in property damage
	Sections describing activities to be performed by qualified persons only
	Information that is important for a specific topic or goal, but is not safety-relevant
<input type="checkbox"/>	Indicates a requirement for meeting a specific goal
<input checked="" type="checkbox"/>	Desired result
	A problem that might occur

1.5 Nomenclature

Complete designation	Designation in this document
Sunny Boy	Inverter, product

Complete designation	Designation in this document
Electronic Solar Switch	ESS
SMA BLUETOOTH Wireless Technology	BLUETOOTH

2 Safety

2.1 Intended Use

The Sunny Boy is a transformerless PV inverter with two MPP trackers which converts the direct current of the PV array to grid-compliant alternating current and feeds it into the utility grid.

The product is suitable for indoor and outdoor use.

The product must only be operated with PV arrays of protection class II in accordance with IEC 61730, application class A. The PV modules must be compatible with this product.

PV modules with a high capacity to ground must only be used if their coupling capacity does not exceed 1.4 μF (for information on how to calculate the coupling capacity, see the Technical Information "Leading Leakage Currents" at www.SMA-Solar.com).

All components must remain within their permitted operating ranges at all times.

The product must only be used in countries for which it is approved or released by SMA Solar Technology AG and the grid operator.

Use this product only in accordance with the information provided in the enclosed documentation and with the locally applicable standards and directives. Any other application may cause personal injury or property damage.

Alterations to the product, e.g. changes or modifications, are only permitted with the express written permission of SMA Solar Technology AG. Unauthorized alterations will void guarantee and warranty claims and usually void the operation permit. SMA Solar Technology AG shall not be held liable for any damage caused by such changes.

Any use of the product other than that described in the Intended Use section does not qualify as appropriate.

The enclosed documentation is an integral part of this product. Keep the documentation in a convenient place for future reference and observe all instructions contained therein.

The type label must remain permanently attached to the product.

2.2 Safety Information

This section contains safety information that must be observed at all times when working on or with the product.

To prevent personal injury and property damage and to ensure long-term operation of the product, read this section carefully and observe all safety information at all times.

⚠ DANGER**Danger to life due to high voltages of the PV array**

When exposed to sunlight, the PV array generates dangerous DC voltage which is present in the DC conductors and the live components of the inverter. Touching the DC conductors or the live components can lead to lethal electric shocks. If you disconnect the DC connectors from the inverter under load, an electric arc may occur leading to electric shock and burns.

- Do not touch non-insulated cable ends.
- Do not touch the DC conductors.
- Do not touch any live components of the inverter.
- Have the inverter mounted, installed and commissioned only by qualified persons with the appropriate skills.
- If an error occurs, have it rectified by qualified persons only.
- Prior to performing any work on the inverter, disconnect it from all voltage sources as described in this document (see Section 10 "Disconnecting the Inverter from Voltage Sources", page 45).

⚠ DANGER**Danger to life due to electric shock**

Touching an ungrounded PV module or array frame can cause a lethal electric shock.

- Connect and ground the PV modules, array frame and electrically conductive surfaces so that there is continuous conduction. Observe the applicable local regulations.

⚠ CAUTION**Risk of burns due to hot enclosure parts**

Some parts of the enclosure can get hot during operation.

- Do not touch any parts other than the lower enclosure lid of the inverter during operation.

NOTICE**Damage to the display or the type label due to the use of cleaning agents**

- If the inverter is dirty, clean the enclosure, the enclosure lid, the type label, the display and the LEDs with a damp cloth only.

3 Scope of Delivery

Check the scope of delivery for completeness and any externally visible damage. Contact your distributor if the scope of delivery is incomplete or damaged.

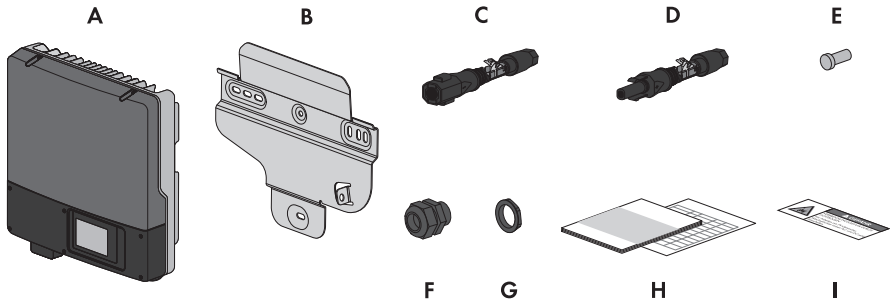

Figure 1: Components included in the scope of delivery

Position	Quantity	Designation
A	1	Inverter*
B	1	Wall mounting bracket
C	4	Positive DC connector
D	4	Negative DC connector
E	8	Sealing plug for DC connectors
F	1	Cable gland M32x1.5
G	1	Counter nut for cable gland M32x1.5
H	1	Quick Reference Guide for Installation, installation manual of the SMA Speedwire/Webconnect data module, installation manual of the DC connectors, supplementary sheet with default settings, supplementary sheet with access data for registration in Sunny Portal
I	1	Warning label

* Optional without Electronic Solar Switch (ESS)

4 Product Description

4.1 Sunny Boy

The Sunny Boy is a transformerless PV inverter with two MPP trackers which converts the direct current of the PV array to grid-compliant alternating current and feeds it into the utility grid.

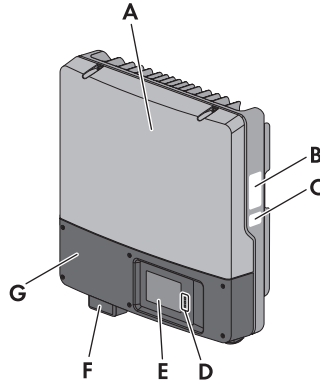







Figure 2: Design of the Sunny Boy











Position	Explanation
A	Upper enclosure lid
B	Type label The type label uniquely identifies the inverter. You will require the information on the type label to use the product safely and when seeking customer support from the SMA Service Line. You will find the following information on the type label: <ul style="list-style-type: none"> • Device type (Model) • Serial number (Serial No.) • Date of manufacture • Device-specific characteristics
C	Additional label with details for registration in Sunny Portal: <ul style="list-style-type: none"> • Internet address of the PV System Setup Assistant • Identification key (PIC) • Registration ID (RID)
D	LEDs The LEDs indicate the operating state of the inverter (see Section 9.1 "LED Signals", page 41).



Position	Explanation
E	<p>Display</p> <p>The display shows the current operating data and events or errors (see Section 9.2 "Display Overview", page 41).</p>
F	<p>Electronic Solar Switch (ESS)*</p> <p>The ESS and the DC connectors together form a DC load-break switch. When plugged in, the ESS forms a conductive path between the PV array and the inverter. Removing the ESS interrupts the DC electric circuit and removing all DC connectors disconnects the PV array completely from the inverter.</p>
G	Lower enclosure lid

* Optional

Symbols on the inverter, the type label and the ESS

Symbol	Explanation
	<p>Inverter</p> <p>Together with the green LED, this symbol indicates the operating state of the inverter.</p>
	<p>Observe the documentation</p> <p>Together with the red LED, this symbol indicates an error (for troubleshooting, see the service manual at www.SMA-Solar.com).</p>
	<p>BLUETOOTH</p> <p>Together with the blue LED, the symbol indicates active communication via BLUETOOTH.</p>
	<p>Danger</p> <p>This symbol indicates that the inverter must be additionally grounded if additional grounding or equipotential bonding is required at the installation site (see Section 6.3.3, page 27).</p>
	<p>QR Code</p> <p>Links to additional information on the inverter can be found at www.SMA-Solar.com.</p>
	<p>Operating the inverter without the lower enclosure lid is prohibited. Always operate the inverter with the lower enclosure lid.</p>

Symbol	Explanation
	<p>Operating principle of the ESS:</p> <ul style="list-style-type: none"> • ① If the ESS is plugged in, the DC electric circuit is closed. • ② To interrupt the DC electric circuit, you must perform the following steps in the given order: <ul style="list-style-type: none"> - ↓ Remove the ESS. - ↻ Unlock and remove all DC connectors.
	<p>Danger to life due to electric shock</p> <p>The product operates at high voltages. All work on the product must be carried out by qualified persons only.</p>
	<p>Risk of burns due to hot surfaces</p> <p>The product can get hot during operation. Avoid contact during operation. Allow the product to cool down sufficiently before carrying out any work.</p>
	<p>Observe the documentation</p> <p>Observe all documentation supplied with the product.</p>
	<p>Direct current</p>
	<p>The product does not have a transformer.</p>
	<p>Alternating current</p>
	<p>WEEE designation</p> <p>Do not dispose of the product together with the household waste but in accordance with the locally applicable disposal regulations for electronic waste.</p>
	<p>CE marking</p> <p>The product complies with the requirements of the applicable EU directives.</p>
	<p>Device class ID</p> <p>The product is equipped with a wireless component and complies with device class 2.</p>
	<p>Degree of protection IP65</p> <p>The product is protected against dust intrusion and water jets from any angle.</p>

Symbol	Explanation
	The product is suitable for outdoor installation.
	Certified safety The product is VDE-tested and complies with the requirements of the German Equipment and Product Safety Act.
	RCM (Regulatory Compliance Mark) The product complies with the requirements of the applicable Australian standards.

4.2 Interfaces and Functions

The inverter can be equipped or retrofitted with the following interfaces and functions:

BLUETOOTH

Via BLUETOOTH, the inverter can communicate with various BLUETOOTH devices (for information on supported SMA products, see www.SMA-Solar.com).

SMA Speedwire/Webconnect

The inverter is equipped with SMA Speedwire/Webconnect as standard. SMA Speedwire/Webconnect is a type of communication based on the Ethernet standard. This enables inverter-optimized 10/100 Mbit data transmission between Speedwire devices in PV systems and the software Sunny Explorer. The Webconnect function enables direct data transmission between the inverters of a small-scale system and the Internet portal Sunny Portal without any additional communication device and for a maximum of four inverters per Sunny Portal system. In large-scale PV power plants, data transmission to the Internet portal Sunny Portal is carried out via the SMA Cluster Controller. You can access your Sunny Portal system from any computer with an Internet connection.

SMA Speedwire/Webconnect enables, for PV systems operated in Italy, the connection to or disconnection of the inverter from the utility grid and definition of the frequency limits to be used with IEC61850-GOOSE messages.

RS485 interface

The inverter can communicate via cables with special SMA communication products via the RS485 interface (information on supported SMA products at www.SMA-Solar.com). The RS485 interface can be retrofitted.

Grid Management Services

The inverter is equipped with service functions for grid management.

Depending on the requirements of the grid operator, you can activate and configure the functions (e.g. active power limitation) via operating parameters.

SMA Power Control Module

The SMA Power Control Module enables the inverter to implement grid management services and is equipped with an additional multifunction relay (for information on installation and configuration, see the installation manual of the SMA Power Control Module). The SMA Power Control Module can be retrofitted.

Multifunction Relay

You can configure the multifunction relay for various operating modes. The multifunction relay is used, for example, to switch fault indicators on or off (for information on installation and configuration, see the installation manual of the multifunction relay). The multifunction relay can be retrofitted.

Fan retrofit kit

The fan retrofit kit is used for additional inverter cooling at high ambient temperatures and also has a multifunction relay (for information on installation and configuration, see the installation manual of the fan retrofit kit). The fan retrofit kit can be retrofitted and must not be operated in parallel with the SMA Power Control Module.

SMA OptiTrac Global Peak

SMA OptiTrac Global Peak is an advancement of SMA OptiTrac and allows the operating point of the inverter to follow the optimal operating point of the PV array (MPP) precisely at all times. In addition, with the aid of SMA OptiTrac Global Peak, the inverter can detect the presence of several maximum power points in the available operating range, such as may occur particularly with partially shaded strings. SMA OptiTrac Global Peak is enabled by default.

All-pole sensitive residual-current monitoring unit

The all-pole sensitive residual-current monitoring unit detects alternating and direct differential currents. In single-phase and three-phase inverters, the integrated differential current sensor detects the current difference between the neutral conductor and the line conductor(s). If the current difference increases suddenly, the inverter disconnects from the utility grid.

5 Mounting

5.1 Requirements for Mounting

Requirements for the mounting location:

⚠ WARNING

Danger to life due to fire or explosion

Despite careful construction, electrical devices can cause fires.

- Do not mount the inverter in areas containing highly flammable materials or gases.
 - Do not mount the inverter in a potentially explosive atmosphere.
-
- The mounting location must be inaccessible to children.
 - A solid support surface must be available for mounting, e.g. concrete or masonry. When mounted on drywall or similar materials in the living area, the inverter emits audible vibrations during operation which could be perceived as annoying.
 - The mounting location must be suitable for the weight and dimensions of the inverter (see Section 11 "Technical Data", page 47).
 - To ensure optimum operation, the ambient temperature should be between -25°C and 40°C .
 - The mounting location should not be exposed to direct solar irradiation. Direct solar irradiation can cause the inverter to overheat. As a result, the inverter reduces its power output.
 - Climatic conditions must be met (see Section 11 "Technical Data", page 47).
 - The mounting location should be freely and safely accessible at all times without the need for any auxiliary equipment (such as scaffolding or lifting platforms). Non-fulfillment of these criteria may restrict servicing.

Dimensions for mounting:

Figure 3: Position of the anchoring points

Recommended clearances:

If you maintain the recommended clearances, adequate heat dissipation will be ensured. Thus, you will prevent power reduction due to excessive temperature.

- Maintain the recommended clearances to walls as well as to other inverters or objects.
- If multiple inverters are mounted in areas with high ambient temperatures, increase the clearances between the inverters and ensure sufficient fresh-air supply.

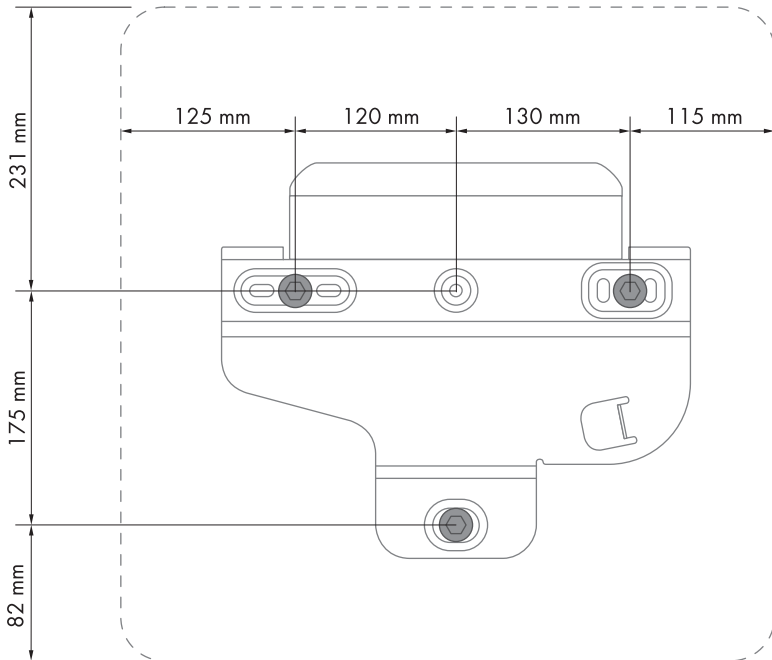
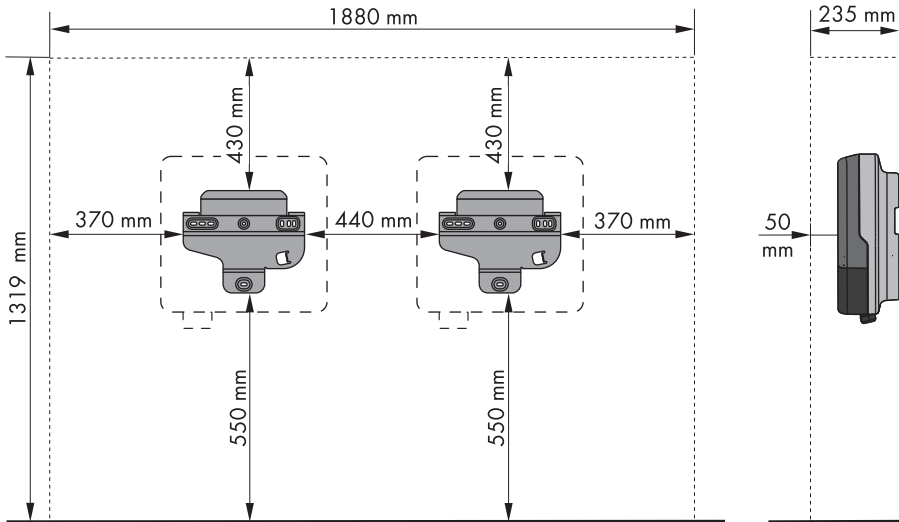

Figure 4: Recommended clearances

Permitted and prohibited mounting positions:

- The inverter must be mounted in one of the permitted positions. This will ensure that no moisture can penetrate the inverter.
- The inverter should be mounted in such way that display messages and LED signals can be read without difficulty.

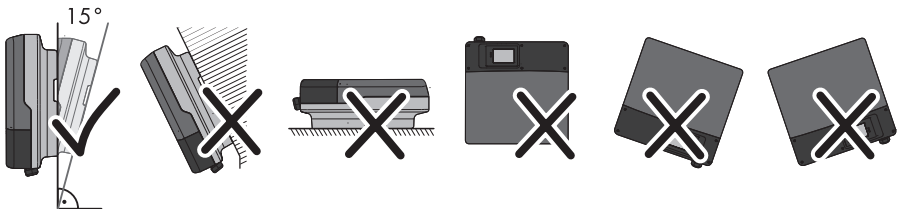

Figure 5: Permitted and prohibited mounting positions

5.2 Mounting the Inverter

⚠ QUALIFIED PERSON

Additionally required mounting material (not included in the scope of delivery):

- Three screws suitable for the support surface (diameter: at least 6 mm)
- Three washers suitable for the screws (outer diameter: at least 18 mm)
- If necessary, three screw anchors suitable for the support surface and the screws
- To secure the inverter against theft: one padlock suitable for outdoor use

⚠ CAUTION

Risk of injury when lifting the inverter, or if it is dropped

The inverter weighs 30 kg. There is risk of injury if the inverter is lifted incorrectly or dropped while being transported or when attaching it to or removing it from the wall mounting bracket.

- Transport and lift the inverter carefully.

Procedure:

1. ⚠ CAUTION

Risk of injury due to damaged cables

There may be power cables or other supply lines (e.g. gas or water) routed in the wall.

- Ensure that no lines are laid in the wall which could be damaged when drilling holes.
2. Align the wall mounting bracket horizontally on the wall and mark the position of the drill holes. Use at least two holes on the right-hand and left-hand side and the lower hole in the middle of the wall mounting bracket.
Useful hint: When mounting on a post, use the upper and lower central holes of the wall mounting bracket.
 3. Set the wall mounting bracket aside and drill the marked holes.
 4. Insert screw anchors into the drill holes if the support surface requires them.
 5. Secure the wall mounting bracket using screws and washers.
 6. Hook the inverter into the wall mounting bracket.
 7. Ensure that the inverter is securely in place.
 8. To protect the inverter against theft or from falling down in the event of an earthquake, use an appropriate padlock.
 - Place the shackle of the padlock through the metal bracket on the wall mounting bracket and through the bracket on the rear of the inverter. Guide the shackle outwards from the center of the inverter.

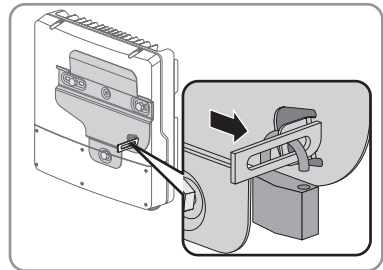

- Close the padlock.
- Keep the key of the padlock in a safe place.

6 Electrical Connection

6.1 Safety during Electrical Connection

⚠ DANGER

Danger to life due to high voltages of the PV array

When exposed to sunlight, the PV array generates dangerous DC voltage which is present in the DC conductors and the live components of the inverter. Touching the DC conductors or the live components can lead to lethal electric shocks. If you disconnect the DC connectors from the inverter under load, an electric arc may occur leading to electric shock and burns.

- Do not touch non-insulated cable ends.
- Do not touch the DC conductors.
- Do not touch any live components of the inverter.
- Have the inverter mounted, installed and commissioned only by qualified persons with the appropriate skills.
- If an error occurs, have it rectified by qualified persons only.
- Prior to performing any work on the inverter, disconnect it from all voltage sources as described in this document (see Section 10 "Disconnecting the Inverter from Voltage Sources", page 45).

NOTICE

Damage to the inverter due to electrostatic discharge

Touching electronic components can cause damage to or destroy the inverter through electrostatic discharge.

- Ground yourself before touching any component.

6.2 Overview of the Connection Area

6.2.1 View from Below

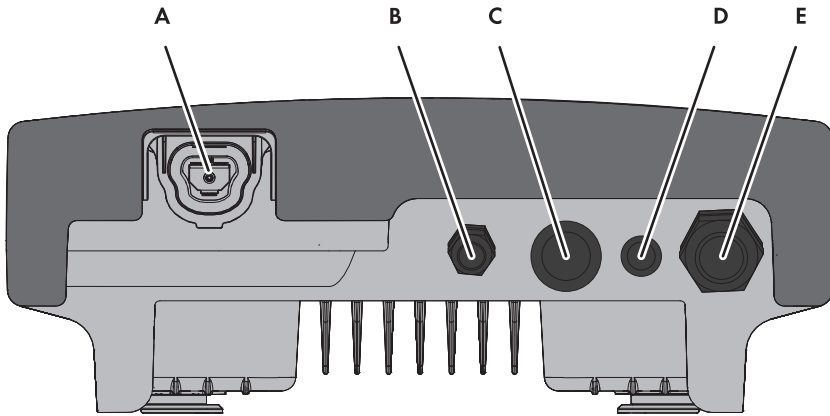

Figure 6: Enclosure openings at the bottom of the inverter

Position	Designation
A	Pin connector for the ESS*
B	Cable gland M20x1.5 for the connection to the multifunction relay or SMA Power Control Module*
C	Enclosure opening with filler plug for cable gland M32x1.5 with two-hole cable support sleeve
D	Enclosure opening with filler plug
E	Cable gland M32x1.5 for the AC cable

* Optional

6.2.2 Interior View

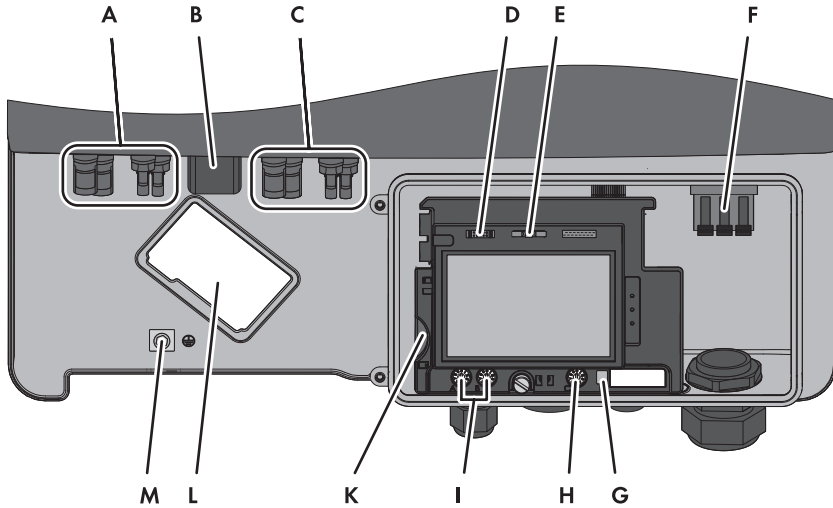

Figure 7: Connection areas in the interior of the inverter

Position	Designation
A	2 positive and 2 negative DC connectors, input A
B	Pin connector for the ESS*
C	2 positive and 2 negative DC connectors, input B
D	Pin connector for connecting the multifunction relay, the SMA Power Control Module or the fan retrofit kit*
E	Pin connector for connecting the Speedwire/Webconnect interface or the RS485 interface*
F	Connecting terminal plate for connecting the AC cable
G	Switch for temporarily changing the display language to English (for service purposes)
H	Rotary switch C for configuring the NetID
I	Rotary switch A and B for setting the country data set and the display language
K	Slot for SD memory card
L	Mounting location for the fan retrofit kit*
M	Grounding terminal for additional grounding of the inverter

* Optional

6.3 AC Connection

6.3.1 Requirements for the AC Connection

Cable requirements:

- External diameter: 12 mm to 21 mm
- Conductor cross-section: 1.5 mm² to 10 mm²
- Insulation stripping length: 12 mm
- The cable must be dimensioned in accordance with the local and national directives for the dimensioning of cables. The requirements for the minimum wire size derive from these directives. Examples of factors influencing cable dimensioning are: nominal AC current, type of cable, routing method, cable bundling, ambient temperature and maximum desired line losses (for calculation of line losses, see the design software "Sunny Design" from software version 2.0 at www.SMA-Solar.com).

Load-break switch and cable protection:

NOTICE

Damage to the inverter due to the use of screw-type fuses as load-break switches

Screw-type fuses (e.g. DIAZED fuse or NEOZED fuse) are not load-break switches.

- Do not use screw-type fuses as load-break switches.
 - Use a load-break switch or circuit breaker as a load disconnection unit (for information and design examples, see the Technical Information "Circuit Breaker" at www.SMA-Solar.com).
- In PV systems with multiple inverters, protect each inverter with a separate circuit breaker. Make sure to observe the maximum permissible fuse protection (see Section 11 "Technical Data", page 47). This will prevent residual voltage being present at the corresponding cable after disconnection.
 - Loads installed between the inverter and the circuit breaker must be fused separately.

Residual-current monitoring unit:

- If an external residual-current device is required, install a residual-current device which trips at a residual current of 100 mA or higher (for details on selecting a residual-current device, see the Technical Information "Criteria for Selecting a Residual-Current Device" at www.SMA-Solar.com).

Overvoltage category:

The inverter can be used in grids of overvoltage category III or lower in accordance with IEC 60664-1. That means that the inverter can be permanently connected to the grid-connection point of a building. In case of installations with long outdoor cabling routes, additional measures to reduce overvoltage category IV to overvoltage category III are required (see the Technical Information "Overvoltage Protection" at www.SMA-Solar.com).

Grounding conductor monitoring:

The inverter is equipped with a grounding conductor monitoring device. This grounding conductor monitoring device detects when there is no grounding conductor connected and disconnects the inverter from the utility grid if this is the case. Depending on the installation site and grid configuration, it may be advisable to deactivate the grounding conductor monitoring. This is necessary, for example, in an IT system if there is no neutral conductor present and you intend to install the inverter between two line conductors. If you are uncertain about this, contact your grid operator or SMA Solar Technology AG.

- Grounding conductor monitoring must be deactivated after initial start-up depending on the grid configuration (see Section 8.5, page 40).

i Safety in accordance with IEC 62109 when the grounding conductor monitoring is deactivated

In order to guarantee safety in accordance with IEC 62109 when the grounding conductor monitoring is deactivated, carry out one of the following measures:

- Connect a grounding conductor made of copper wire with a cross-section of at least 10 mm² to the connecting terminal plate for the AC cable.
- Connect additional grounding with the same cross-section as the connected grounding conductor to the connecting terminal plate for the AC cable (see Section 6.3.3, page 27). This prevents touch current if the grounding conductor at the connecting terminal plate for the AC cable fails.

i Connection of additional grounding

In some countries, additional grounding is generally required. In each case, observe the locally applicable regulations.

- If additional grounding is required, connect an additional grounding with the same cross-section as the connected grounding conductor to the connecting terminal plate for the AC cable (see Section 6.3.3, page 27). This prevents touch current if the grounding conductor at the connecting terminal plate for the AC cable fails.

6.3.2 Connecting the Inverter to the Utility Grid**⚠ QUALIFIED PERSON****Requirements:**

- The connection requirements of the grid operator must be met.
- The grid voltage must be in the permissible range. The exact operating range of the inverter is specified in the operating parameters.

Procedure:

1. Disconnect the circuit breaker and secure it against reconnection.
2. If an additional DC load-break switch is available, switch off the DC load-break switch and secure against reconnection.
3. If the ESS is installed and plugged in, remove the ESS.
4. If the lower enclosure lid is mounted, loosen all screws of the lower enclosure lid using an Allen key (AF 3) and remove the enclosure lid.

5. Loosen the screw on the display and flip the display up to have more space to make the connection.

☑ The display clicks into place.

6. Unscrew the swivel nut from the cable gland.

7. If the outer diameter of the cable is between 15 mm and 21 mm, remove the inner sealing ring from the cable gland.

8. Move the swivel nut of the cable gland over the AC cable and then route the AC cable through the cable gland into the inverter.

9. Dismantle the AC cable.

10. Shorten L and N by 5 mm each.

11. Strip the insulation of L, N and the grounding conductor by 18 mm.

12. Push the locking levers of the connecting terminal plate for the AC cable right up to the stop.

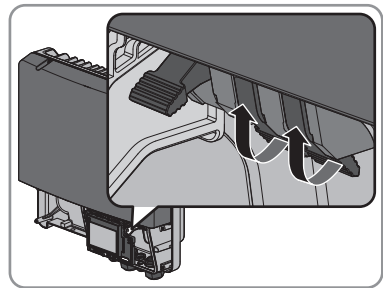

13. Connect the grounding conductor, N and L to the connecting terminal plate for the AC cable in accordance with the labeling.

14. **⚠ CAUTION**

Danger of crushing fingers when locking levers snap shut

The locking levers close by snapping down fast and hard.

- Press the locking levers of the connecting terminal plate for the AC cable down with your thumb only.

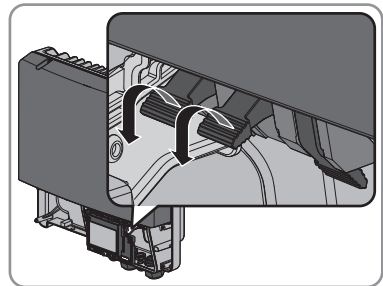

- Do not grip the entire connecting terminal plate for the AC cable.
- Do not place your fingers under the locking levers.

15. Make sure that all conductors are securely in place.

16. Screw the swivel nut onto the cable gland.

17. If the display is flipped up, flip it down and tighten the screw.

6.3.3 Connecting Additional Grounding

⚠ QUALIFIED PERSON

If additional grounding or equipotential bonding is required locally, you can connect additional grounding to the inverter. This prevents touch current if the grounding conductor at the terminal for the AC cable fails.

Cable requirement:

- Grounding cable cross-section: max. 10 mm²

Procedure:

1. Strip the grounding cable insulation.
2. Release the screw using an Allen key (AF 4) until the grounding cable can be led under the clamping bracket.

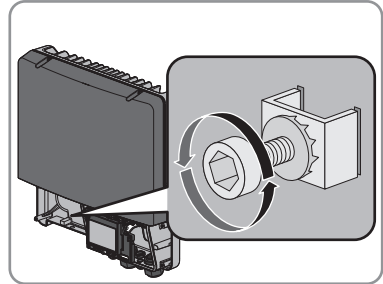

3. Feed the grounding cable under the clamping bracket. Position the grounding conductor on the left-hand side.
4. Tighten the clamping bracket with the screw and conical spring washer (torque: 6 Nm). The teeth of the conical spring washer must face the clamping bracket.

6.4 DC Connection

6.4.1 Requirements for the DC Connection

Requirements for the PV modules per input:

- All PV modules must be of the same type.
- All PV modules must be aligned and tilted identically.
- On the coldest day based on statistical records, the open-circuit voltage of the PV array must never exceed the maximum input voltage of the inverter.
- The same number of series-connected PV modules must be connected to each string.
- The maximum input current per string must be maintained and must not exceed the through-fault current of the DC connectors (see Section 1.1 "Technical Data", page 47).
- The thresholds for the input voltage and the input current of the inverter must be adhered to (see Section 1.1 "Technical Data", page 47).

- The positive connection cables of the PV modules must be fitted with the positive DC connectors (for information on assembling DC connectors, see the DC connector installation manual).
- The negative connection cables of the PV modules must be fitted with the negative DC connectors (for information on assembling DC connectors, see the DC connector installation manual).
- If the inverter is not equipped with an ESS and the regulations in the country of installation require an external DC load-break switch, you must install an external DC load-break switch.

i **Use of Y adapters for parallel connection of strings**

The Y adapters must not be used to interrupt the DC circuit.

- Do not use the Y adapters in the immediate vicinity of the inverter. The adapters must not be visible or freely accessible.
- In order to interrupt the DC circuit, always disconnect the inverter as described in this document (see Section 10, page 45).

i **Reduced electromagnetic compatibility of the inverter in case of incorrect DC connection**

If the positive terminal and the negative terminal of a string are not connected to the same input, electromagnetic compatibility of the inverter cannot be guaranteed. As a result, the inverter can cause electromagnetic interference in other devices.

- Always connect the positive terminal and the negative terminal of one string to the same input.

6.4.2 Connecting the PV Array

⚠ QUALIFIED PERSON

NOTICE

Destruction of the inverter due to overvoltage

If the open-circuit voltage of the PV modules exceeds the maximum input voltage of the inverter, the inverter can be destroyed due to overvoltage.

- If the open-circuit voltage of the PV modules exceeds the maximum input voltage of the inverter, do not connect any strings to the inverter and check the design of the PV system.

NOTICE

Destruction of the measuring device due to overvoltage

- Only use measuring devices with a DC input voltage range of 1,000 V or higher.

NOTICE**Damage to the DC connectors due to the use of contact cleaner of other cleaning agents**

Some contact cleaners or other cleaning agents may contain substances that decompose the plastic of the DC connectors.

- Do not use contact cleaners or other cleaning agents for cleaning the DC connectors.

Procedure:

1. Ensure that the circuit breaker is switched off and that it cannot be reconnected.
2. If an additional DC load-break switch is available, switch off the DC load-break switch and secure against reconnection.
3. If the ESS is installed and plugged in, remove the ESS.
4. Ensure that there is no ground fault in the PV array (see service manual at www.SMA-Solar.com).
5. Check whether the DC connectors have the correct polarity.
If the DC connector is equipped with a DC cable of the wrong polarity, the DC connector must be assembled again. The DC cable must always have the same polarity as the DC connector.
6. Ensure that the open-circuit voltage of the PV array does not exceed the maximum input voltage.
7. Connect the assembled DC connectors to the inverter.
 - The DC connectors snap into place.
8. Ensure that all DC connectors are securely in place.

9. **NOTICE**

Damage to the inverter due to moisture ingress

The inverter is only properly sealed when all unused DC inputs are closed with DC connectors and sealing plugs.

- Do not insert the sealing plugs directly into the DC inputs on the inverter.
- For unused DC connectors, push down the clamping bracket and push the swivel nut up to the thread.

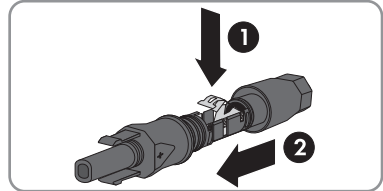

- Insert the sealing plug into the DC connector.

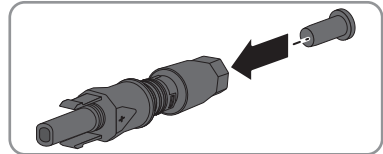

- Tighten the DC connector (torque: 2 Nm).

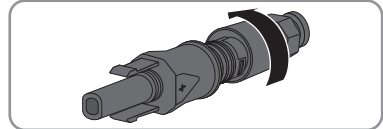

- Insert the DC connectors with sealing plugs into the corresponding DC inputs on the inverter.

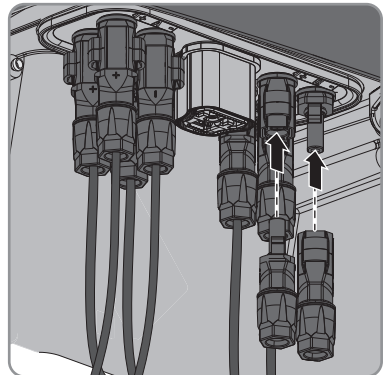

- The DC connectors snap into place.
- Ensure that all DC connectors with sealing plugs are securely in place.

7 Commissioning

7.1 Commissioning Procedure

QUALIFIED PERSON

Before you can commission the inverter, you must check various settings and make changes if necessary. This section describes the procedure and gives an overview of the steps, which must always be performed in the prescribed sequence.

Procedure	See
1. Connect to the communication interface.	Installation manual of the communication interface
2. Check the country data set configuration of the inverter.	Supplementary sheet with the default settings, type label or display
3. If the country data set is not set correctly for your country or your purpose, adjust to the required country data set and the corresponding display language within the first ten feed-in hours via the rotary switches in the inverter.	Section 7.2, page 31
4. If the inverter is to communicate with several BLUETOOTH devices, or if BLUETOOTH is not to be used as a type of communication, set the NetID.	Section 7.3, page 32
5. Commission the inverter and start a self-test, if required.	Section 7.4, page 34 and Section 7.5, page 35

7.2 Configuring the Country Data Set

QUALIFIED PERSON

A display language is assigned to every country data set. Set the country data set appropriate for your country or purpose, with the corresponding display language, within the first ten feed-in hours via the rotary switches in the inverter. After the first ten feed-in hours, the country data set can only be changed by means of a communication product.

If the display language of the country data set does not match the required language, you can change it after commissioning (see Section 8.2 "Changing the Display Language", page 38).

The country data set must be set correctly.

If you select a country data set which is not valid for your country and purpose, it can cause a disturbance in the PV system and lead to problems with the grid operator. When selecting the country data set, you must always observe the locally applicable standards and directives as well as the properties of the PV system (e.g. PV system size, grid-connection point).

- If you are not sure which country data set is valid for your country or purpose, contact your grid operator for information on which country data set is to be configured.

Procedure:

1. Determine the rotary switch position for your country and purpose. Call up the Technical Information "Overview of the Rotary Switch Settings" at www.SMA-Solar.com.

2. **⚠ DANGER**

Danger to life due to high voltages

- Ensure that the inverter is disconnected from all voltage sources and that the enclosure lid is removed (see Section 10, page 45).

3. Set the rotary switches **A** and **B** to the required position using a flat-blade screwdriver (blade width: 2.5 mm).

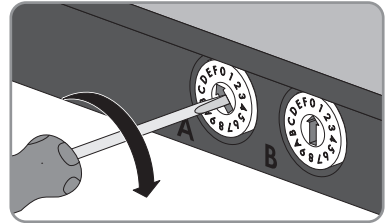

- The inverter will adopt the setting after commissioning. This can take up to five minutes.

7.3 Setting the NetID

⚠ QUALIFIED PERSON

By default, the NetID is set to **1** for all SMA inverters and SMA communication products with BLUETOOTH. If your PV system consists of an inverter and a maximum of one further BLUETOOTH device (e.g. computer with BLUETOOTH interface or SMA communication product), you can leave the NetID set to **1**.

You must change the NetID in the following cases:

- If your PV system consists of one inverter and two other BLUETOOTH devices (e.g. computer with BLUETOOTH interface and SMA communication product) or of multiple inverters with BLUETOOTH, you must change the NetID of your PV system. This will enable communication with multiple BLUETOOTH devices.
- If another PV system with BLUETOOTH is located within 500 m of your PV system, you must change the NetID of your PV system. This will help keep both PV systems separate.
- If you do not wish to communicate via BLUETOOTH, deactivate the BLUETOOTH communication on your inverter. This will protect your PV system from unauthorized access.

All BLUETOOTH devices in a PV system must have the same NetID. You can set a new NetID in the inverter by means of the rotary switch **C**.

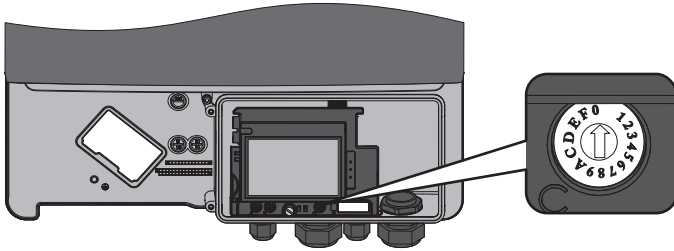

Figure 8: Positions of rotary switch C

Position	Explanation
0	Communication via BLUETOOTH is deactivated.
1	Communication via BLUETOOTH with a further BLUETOOTH device
2 to F	NetID for communication via BLUETOOTH with multiple BLUETOOTH devices

Procedure:

1. **⚠ DANGER**

Danger to life due to high voltages

- Ensure that the inverter is disconnected from all voltage sources (see Section 10, page 45).

2. To set a new NetID, set the rotary switch **C** to the determined NetID using a flat-blade screwdriver (blade width: 2.5 mm).

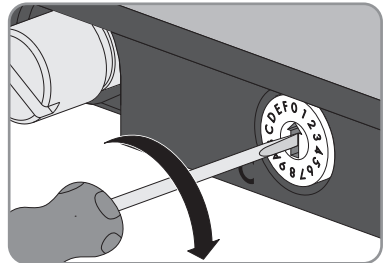

3. To deactivate communication via BLUETOOTH, set the rotary switch **C** to position **0** using a flat-blade screwdriver (blade width: 2.5 mm). This will protect your PV system from unauthorized access.

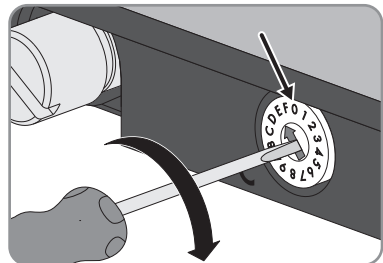

The inverter will adopt the setting after commissioning. This can take up to five minutes.

7.4 Commissioning the Inverter

⚠ QUALIFIED PERSON

Requirements:

- The inverter must be correctly mounted.
- The circuit breaker must be correctly rated and mounted.
- All cables must be completely and correctly connected.
- Unused DC inputs must be sealed using the corresponding DC connectors and sealing plugs.
- The country data set must be set correctly for the country or the purpose.

Procedure:

1. Insert the lower enclosure lid from above and flip it down. The screws must protrude from the lower enclosure lid.

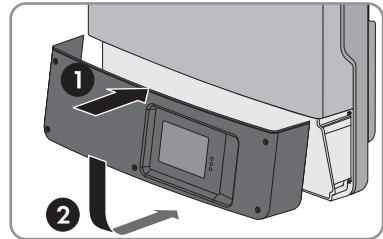

2. Tighten all screws of the lower enclosure lid using an Allen key (AF 3) in the order 1 to 6 (torque: $2 \text{ Nm} \pm 0.3 \text{ Nm}$).
Useful hint: If the screws fall out of the lower enclosure lid, insert the short screw in the upper middle hole and the five long screws in the other holes.

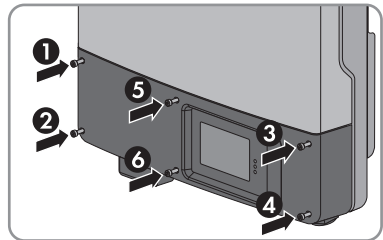

3. If the ESS is available, plug it in. The ESS must be aligned parallel to and flush with the enclosure.
 4. **i** **Currents in the DC cabling after plugging in the ESS**
After plugging in the ESS, DC currents may occur in the DC cabling, even when there is no AC-side supply. This is not an error but normal behavior of the inverter when in operation.
 5. Attach the supplied warning labels so that they are clearly visible on the disconnection point on the AC side.
 6. Switch on the circuit breaker.
 7. If an external DC load-break switch is installed, switch it on.
 8. If the multifunction relay is used, connect the supply voltage to the load.
- All three LEDs start to glow and the start-up phase begins. The start-up phase may take several minutes.

i Self-test in accordance with CEI 0-21 during commissioning (applies to Italy only)

The Italian standard prescribes that an inverter can only be operated on the utility grid after the disconnection times for overvoltage, undervoltage, minimum frequency and maximum frequency have been checked.

- If the country data set is configured to **CEI 0-21 Int / CEI 0-21 internal**, start the self-test as soon as the display shows the country data set (see Section 7.5.1 "Starting the Self-Test", page 35).
- ☑ The green LED is glowing and the display alternates automatically between the device type, firmware version, the serial number or designation of the inverter, the NetID, the configured country data set and the display language.
- ✗ The green LED is flashing?
Possible cause of error: the DC input voltage is still too low or the inverter is monitoring the utility grid.
 - Once the DC input voltage is sufficiently high and the grid-connection conditions are met, the inverter will start operation.
- ✗ The red LED is glowing and an error message and event number appear in the display?
An error has occurred.
 - Rectify the error (see service manual at www.SMA-Solar.com).

7.5 Self-Test in Accordance with CEI 0-21 for PV Systems ≤6 kW

7.5.1 Starting the Self-Test

▲ QUALIFIED PERSON

i The self-test only applies to inverters that are configured with the country data set **CEI 0-21 Int** or **CEI 0-21 internal**.

The self-test is only valid for inverters licensed for Italy and configured with the country data set **CEI 0-21 Int** or **CEI 0-21 internal**.

If the inverter is configured to the country data set **CEI 0-21 Ext** or **CEI 0-21 external**, no self-test is required.

The self-test is only required for inverters to be commissioned in Italy. The Italian standard requires that all inverters feeding into the utility grid are equipped with a self-test function in accordance with CEI 0-21. During the self-test, the inverter will consecutively check the reaction times for overvoltage, undervoltage, maximum frequency and minimum frequency.

The self-test changes the upper and lower disconnection values for each protective function on a linear basis for frequency monitoring and voltage monitoring. As soon as the measured value exceeds the permitted disconnection threshold, the inverter disconnects from the utility grid. In this way, the inverter determines the reaction time and checks itself.

After the self-test has been completed, the inverter automatically switches back to feed-in operation, resets the original disconnection conditions and connects to the utility grid. The test takes approximately three minutes.

Requirements:

- Configured country data set: **CEI 0-21 Int** or **CEI 0-21 internal** or amended country data set **trimmed** or **Special setting** based on one of the country data sets mentioned above.
- A report for entering the test results according to CEI 0-21 must be available.
- The inverter must be in operation and in the start-up phase.

Procedure:

1. As soon as the configured country data set appears in the display, tap once on the display within ten seconds.
 - A message informing you that the self-test has started is shown in the display:
Avvio Autotest.
 - The message **Avvio Autotest** is not shown in the display?
The ten seconds have elapsed so the self-test cannot start.
 - Restart the self-test (see Section 7.5.2, page 36).
2. Tap on the display within 20 seconds and enter the subsequent test results into the test report.
 - The self-test starts.
 - The inverter displays the results of the individual tests for overvoltage, undervoltage, maximum frequency and minimum frequency. The results are displayed three times in succession for ten seconds each.
Useful hint: If you want to have the next result displayed without waiting ten seconds, tap twice on the enclosure lid.
 - The information **Autotest interrotto** is shown in the display?
The self-test was cancelled due to an unexpected disconnection condition or the DC voltage is too low to continue grid feed-in.
 - Restart the self-test (see Section 7.5.2, page 36).

Example: Display messages for overvoltage test

- Name of the test: **Autotest (59.S1) 240.00V**
- Disconnection value: **Valore di soglia con 230.00V**
- Normative value: **Va. taratura 253.00V**
- Disconnection time: **Tempo die intervento 0.02 s**
- Current grid voltage: **Tensione di rete Val.eff.: 229.80V**

7.5.2 Restarting the Self-Test**⚠ QUALIFIED PERSON**

1. Disconnect the circuit breaker and secure it against reconnection.
2. If the multifunction relay is used, disconnect the supply voltage to the load.
3. If an external DC load-break switch is used, switch it off for five minutes and then switch it on again.

4. If an ESS is in use, pull it out of the inverter for five minutes and then plug it in again firmly.
 5. Recommission the inverter.
- The inverter is back in the start-up phase and you can start the self-test once again (see Section 7.5.1, page 35).

8 Configuration

8.1 Configuration Procedure

Once you have commissioned the inverter, you may have to adjust various settings via the rotary switches in the inverter or via a communication product. This section describes the procedure for configuration and gives an overview of the steps you must perform in the prescribed order.

Procedure	See
1. If the display language is not set correctly, adjust the settings.	Section 8.2, page 38
2. In order to use the Webconnect function, integrate the inverter into the network.	Section 8.3, page 39
3. To manage the PV system data or to set the inverter parameters, capture the inverter in a communication product.	Manual of the communication product at www.SMA-Solar.com
4. In order to receive control commands of the grid operator via SMA Speedwire/Webconnect for PV systems in Italy, set the parameters.	Manual of the Speedwire/Webconnect interface
5. Change the system time and system password.	Manual of the communication product at www.SMA-Solar.com
6. If the inverter is installed in an IT network or another grid configuration where deactivation of the grounding conductor monitoring is required, deactivate the grounding conductor monitoring.	Section 8.5, page 40
7. For partially shaded PV modules and depending on the given shading situation, you should set the interval at which the inverter optimizes the MPP of the PV system.	Section 8.6, page 40

8.2 Changing the Display Language

QUALIFIED PERSON

If the language for the country data set is not the language you want to use, you can change the display language as follows:

Procedure:

-  **DANGER**

Danger to life due to high voltages

- Disconnect the inverter from all voltage sources and open the enclosure lid (see Section 10, page 45).

2. Determine the rotary switch setting for the desired display language. Call up the Technical Information "Overview of the Rotary Switch Settings" at www.SMA-Solar.com.

3. Set the rotary switch **A** to **0** using a flat-blade screwdriver (blade width: 2.5 mm). This ensures that the selected data country set remains unchanged.

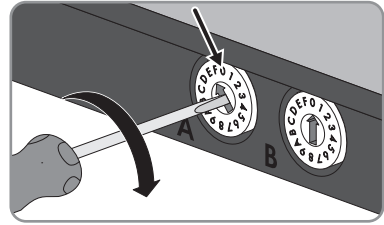

4. Set the rotary switch **B** to the required language using a flat-blade screwdriver (blade width: 2.5 mm).

5. Recommission the inverter (see service manual at www.SMA-Solar.com).

The inverter adopts the settings after commissioning. This can take up to five minutes.

8.3 Integrating the Inverter into the Network

If the router supports DHCP and DHCP is enabled, the inverter will automatically be integrated into the network. You will not need to carry out network configuration.

If the router does not support DHCP, automatic network configuration will not be possible and you will need to use the SMA Connection Assist to integrate the inverter into the network.

Requirements:

- The inverter must be in operation.
- There must be a router with Internet connection in the local network of the system.
- The inverter must be connected to the router.

Procedure:

- Integrate the inverter into the network by means of the SMA Connection Assist. Download the SMA Connection Assist and install it on the computer (see www.SMA-Solar.com).

8.4 Changing Operating Parameters

⚠ QUALIFIED PERSON

This section describes the basic procedure for changing operating parameters. Always change operating parameters as described in this section. Some parameters that have sensitive functions can only be viewed and changed by qualified persons (for further information on changing parameters, refer to the manual of the communication product).

The operating parameters of the inverter are set to certain values by default. To optimize inverter operation, you can change the operating parameters using a communication product.

Requirements:

- Depending on the type of communication, a computer with BLUETOOTH or Ethernet interface must be available.

- A communication product corresponding to the type of communication used must be available.
- The inverter must be registered in the communication product.
- The changes to the grid-relevant parameters must be approved by the responsible grid operator.
- When changing grid-relevant parameters, the SMA Grid Guard code must be available (see "Application for SMA Grid Guard Code" at www.SMA-Solar.com).

Procedure:

1. Call up the user interface of the communication product or software and log in as **Installer** or **User**.
2. If required, enter the SMA Grid Guard code.
3. Select and set the required parameter.
4. Save settings.

8.5 Deactivating Grounding Conductor Monitoring

QUALIFIED PERSON

If the inverter is to be installed in an IT network or another grid configuration in which deactivation of the grounding conductor monitoring is required, deactivate the grounding conductor monitoring as follows.

The basic procedure for changing operating parameters is explained in another section (see Section 8.4 "Changing Operating Parameters", page 39).

Procedure:

- Set the parameter **PE connection monitoring** or **PEOpnMon** to **Off**.

8.6 Setting SMA OptiTrac Global Peak

QUALIFIED PERSON

For partially shaded PV modules, you should set the interval at which the inverter is to optimize the MPP of the PV system.

The basic procedure for changing operating parameters is explained in another section (see Section 8.4 "Changing Operating Parameters", page 39).

Procedure:

- Select the parameter **Cycle time of the OptiTrac Global Peak algorithm** or **MPPShdw.CycTms** and set the required time interval. The ideal time interval is usually six minutes. This value should only be increased if the shading situation changes extremely slowly.
- The inverter optimizes the MPP of the PV system at the predetermined time interval.

9 Operation

9.1 LED Signals

The LEDs indicate the operating state of the inverter.

LED	Status	Explanation
Green LED	glowing	Feed-in operation If an event occurs during feed-in operation, an event message will be shown on the display (for event messages see the service manual at www.SMA-Solar.com).
	flashing	The conditions for feed-in operation are not yet met. As soon as the conditions are met, the inverter will start feed-in operation.
Red LED	glowing	Error If an error occurs, the error message and the corresponding event number will be shown in the display. The error must be rectified by a qualified person (for troubleshooting, see the service manual at www.SMA-Solar.com).
Blue LED	glowing	BLUETOOTH communication is activated.

9.2 Display Overview

The display shows the current operating data of the inverter (e.g. current power, daily energy, total energy) as well as events or errors. Power and energy are displayed as bars in a diagram.

There is a slot for an SD memory card on the left edge of the display enclosure. You can use the SD memory card to carry out an inverter firmware update, for example (for information on firmware updates with an SD memory card see the technical description "Firmware Update with SD Card" at www.SMA-Solar.com).

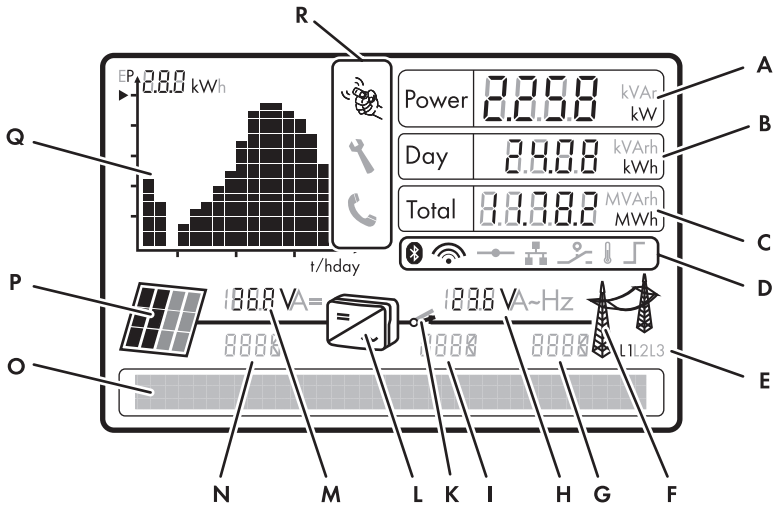















Figure 9: Layout of the display (example)

Position	Symbol	Explanation
A	-	Current power
B	-	Energy on the current day
C	-	Total amount of energy fed in

Position	Symbol	Explanation
D		Active BLUETOOTH connection
		Quality of the BLUETOOTH connection
		Active connection to a Speedwire network
		Active connection to Sunny Portal
		Multifunction relay is active
		Power limitation due to excessive temperature
		Active power limitation via PV system control
E	-	Line conductor to which the displayed values apply
F		Utility grid
G	-	Event number of an error on the utility grid side
H	-	Output voltage or output current of a line conductor
I	-	Event number of an error in the inverter
K		Grid relay When the grid relay is closed, the inverter feeds into the utility grid. When the grid relay is open, the inverter is disconnected from the utility grid.
L		Inverter
M	-	Input voltage or input current of a line conductor
N	-	Event number of an error on the PV array side
O	-	Text line to display event and error messages
P		PV Array

Position	Symbol	Explanation
Q	-	Diagram with the power curve of the last 16 feed-in hours or energy yields of the last 16 days <ul style="list-style-type: none"> In order to switch between diagrams, tap once on the enclosure lid.
R		You can operate the display by tapping on the enclosure lid (see Section 9.3, page 44).
		The displayed error must be rectified on-site by a qualified person (for troubleshooting, see service manual at www.SMA-Solar.com).
		The displayed error cannot be rectified on-site. <ul style="list-style-type: none"> Contact Service (see Section 13, page 55).

9.3 Activating and Operating the Display

You can activate and operate the display by tapping on the enclosure lid.

Procedure:

1. Activate the display. Tap on the enclosure lid once.
 - The backlight is switched on.
2. To move to the next line, tap on the enclosure lid once.
3. In order to switch between the power curve of the last 16 feed-in hours and the energy yields of the last 16 days in the diagram, tap on the enclosure lid once.

9.4 Calling Up Display Messages of the Start-Up Phase

Various inverter information is displayed during the start-up phase that can be called up whenever required during operation.

Procedure:

- Tap on the enclosure lid twice.
- The display shows all messages of the start-up phase in sequence.

10 Disconnecting the Inverter from Voltage Sources

⚠ QUALIFIED PERSON

Prior to performing any work on the inverter, always disconnect it from all voltage sources as described in this section. Always adhere to the prescribed sequence.

NOTICE

Destruction of the measuring device due to overvoltage

- Only use measuring devices with a DC input voltage range of 1,000 V or higher.

Procedure:

1. Disconnect the circuit breaker and secure it against reconnection.
2. If an additional DC load-break switch is available, switch off the DC load-break switch and secure against re-connection.
3. If an ESS is plugged in, remove the ESS.
4. If the multifunction relay is used, switch off any supply voltage to the load.
5. Wait until the LEDs, the display and if necessary, the load connected to the multifunction relay, are switched off.
6. Use a current clamp to ensure that no current is present in the DC cables.
7. Remove all screws of the lower enclosure lid using an Allen key (AF 3) and remove the enclosure lid.
8. Release and remove all DC connectors. Insert a slotted screwdriver or an angled screwdriver (blade width 3.5 mm) into one of the slide slots and pull the DC connectors out downwards. Do not pull on the cable.

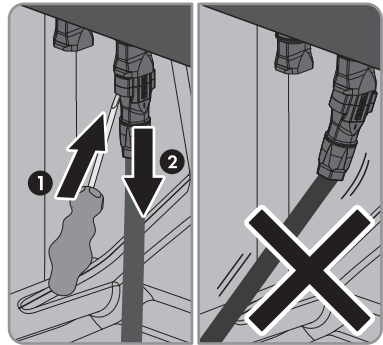

9. Ensure that no voltage is present at the DC inputs of the inverter.
10. Use a suitable measuring device to check that no voltage is present at the AC connecting terminal plate between **L** and **N** and **L** and **PE**. Insert the test probe (maximum diameter: 2 mm) in each round opening of the terminal.
11. Flip the display up to have more space to make the measurement. Loosen the screw on the display.
 - The display clicks into place.
12. Ensure that no voltage is present between any terminal of the multifunction relay and **PE** of the AC connecting terminal plate.

13.

<i>NOTICE</i>

Damage to the inverter due to electrostatic discharge

The internal components of the inverter can be irreparably damaged by electrostatic discharge.

- Ground yourself before touching any component.

11 Technical Data

11.1 DC/AC

11.1.1 Sunny Boy 3000TL / 3600TL

DC Input

	SB 3000TL-21	SB 3600TL-21
Maximum DC power at $\cos \varphi = 1$	3,200 W	3,880 W
Maximum input voltage	750 V	750 V
MPP voltage range	175 V to 500 V	175 V to 500 V
Rated input voltage	400 V	400 V
Minimum input voltage	125 V	125 V
Initial input voltage	150 V	150 V
Maximum input current, input A	15 A	15 A
Maximum input current, input B	15 A	15 A
Maximum short-circuit current per input*	20 A	20 A
Maximum reverse current from the inverter in the system for max. 1 ms	0 A	0 A
Number of independent MPP inputs	2	2
Strings per MPP input	2	2
Overvoltage category in accordance with IEC 60664-1	II	II

* In accordance with IEC 62109-2: $I_{SC PV}$

AC Output

	SB 3000TL-21	SB 3600TL-21
Rated power at 230 V, 50 Hz	3,000 W	3,680 W
Maximum apparent AC power	3,000 VA	3,680 VA
Rated grid voltage	230 V	230 V
Nominal AC voltage	220 V / 230 V / 240 V	220 V / 230 V / 240 V
AC voltage range*	180 V to 280 V	180 V to 280 V
Nominal AC current at 220 V	13.6 A	16.0 A
Nominal AC current at 230 V	13.0 A	16.0 A
Nominal AC current at 240 V	12.5 A	15.3 A

	SB 3000TL-21	SB 3600TL-21
Maximum output current	16 A	16 A
Total harmonic distortion of the output current with total harmonic distortion of the AC voltage < 2%, and AC power > 50% of the rated power	≤4%	≤4%
Inrush current	< 20% of the nominal AC current for a maximum of 10 ms	< 20% of the nominal AC current for a maximum of 10 ms
Maximum output current under fault conditions	34 A	34 A
Rated power frequency	50 Hz	50 Hz
AC power frequency*	50 Hz / 60 Hz	50 Hz / 60 Hz
Operating range at AC power frequency 50 Hz	45 Hz to 55 Hz	45 Hz to 55 Hz
Operating range at AC power frequency 60 Hz	55 Hz to 65 Hz	55 Hz to 65 Hz
Power factor at rated power	1	1
Displacement power factor $\cos \varphi$, adjustable	0.8 underexcited to 1 to 0.8 overexcited	0.8 underexcited to 1 to 0.8 overexcited
Feed-in phases	1	1
Connection phases	1	1
Overvoltage category in accordance with IEC 60664-1	III	III

* depending on the configured country data set

Efficiency

	SB 3000TL-21	SB 3600TL-21
Maximum efficiency, η_{\max}	97.0%	97.0%
European weighted efficiency, η_{EU}	96.0%	96.4%

11.1.2 Sunny Boy 4000TL / 5000TL

DC Input

	SB 4000TL-21	SB 5000TL-21
Maximum DC power at $\cos \varphi = 1$	4,200 W	5,200 W
Maximum input voltage	750 V	750 V
MPP voltage range	175 V to 500 V	175 V to 500 V
Rated input voltage	400 V	400 V
Minimum input voltage	125 V	125 V

	SB 4000TL-21	SB 5000TL-21
Initial input voltage	150 V	150 V
Maximum input current, input A	15 A	15 A
Maximum input current, input B	15 A	15 A
Maximum short-circuit current per input*	20 A	20 A
Maximum reverse current from the inverter in the system for max. 1 ms	0 A	0 A
Number of independent MPP inputs	2	2
Strings per MPP input	2	2
Overvoltage category in accordance with IEC 60664-1	II	II

* In accordance with IEC 62109-2: $I_{SC PV}$

AC Output

	SB 4000TL-21	SB 5000TL-21
Rated power at 230 V, 50 Hz	4,000 W	4,600 W
Maximum apparent AC power	4,000 VA	5,000 VA
Rated grid voltage	230 V	230 V
Nominal AC voltage	220 V / 230 V / 240 V	220 V / 230 V / 240 V
AC voltage range*	180 V to 280 V	180 V to 280 V
Nominal AC current at 220 V	18.2 A	20.9 A
Nominal AC current at 230 V	17.4 A	20.0 A
Nominal AC current at 240 V	16.7 A	19.2 A
Maximum output current	22 A	22 A
Total harmonic distortion of the output current with total harmonic distortion of the AC voltage < 2%, and AC power > 50% of the rated power	≤4%	≤4%
Inrush current	< 20% of the nominal AC current for a maximum of 10 ms	< 20% of the nominal AC current for a maximum of 10 ms
Maximum output current under fault conditions	34 A	34 A
Rated power frequency	50 Hz	50 Hz
AC power frequency*	50 Hz / 60 Hz	50 Hz / 60 Hz
Operating range at AC power frequency 50 Hz	45 Hz to 55 Hz	45 Hz to 55 Hz

	SB 4000TL-21	SB 5000TL-21
Operating range at AC power frequency 60 Hz	55 Hz to 65 Hz	55 Hz to 65 Hz
Power factor at rated power	1	1
Displacement power factor $\cos \varphi$, adjustable	0.8 underexcited to 1 to 0.8 overexcited	0.8 underexcited to 1 to 0.8 overexcited
Feed-in phases	1	1
Connection phases	1	1
Overvoltage category as per IEC 60664-1	III	III

* depending on the configured country data set

Efficiency

	SB 4000TL-21	SB 5000TL-21
Maximum efficiency, η_{\max}	97.0%	97.0%
European weighted efficiency, η_{EU}	96.4%	96.5%

11.2 General Data

Width x height x depth, without Electronic Solar Switch	490 mm x 490 mm x 185 mm
Width x height x depth, with Electronic Solar Switch	490 mm x 519 mm x 185 mm
Weight	26 kg
Length x width x height of the packaging	597 mm x 617 mm x 266 mm
Transport weight	30 kg
Climatic category in accordance with IEC 60721-3-4	4K4H
Environmental category	Outdoors
Pollution degree outside the enclosure	3
Pollution degree inside the enclosure	2
Operating temperature range	-25 °C to +60 °C
Maximum permissible value for relative humidity, non-condensing	100%
Maximum operating altitude above mean sea level (MSL)	2,000 m
Typical noise emission	25 dB(A)
Power loss in night mode	<1 W

Maximum data volume per inverter with Speed-wire/Webconnect	550 MB/month
Additional data volume when using the Sunny Portal live interface	660 kB/hour
Topology	Transformerless
Cooling method	Convection
Degree of protection for electronics in accordance with IEC 60529	IP65
Protection class in accordance with IEC 61140	I
Grid configurations*	IT, Delta-IT, TN-C, TN-S, TN-C-S, split phase, TT (if $V_{N,PE} < 20\text{ V}$)
Approvals and national standards, as per 10/2014**	AS4777:2005, CE, CEI 0-21, C10/11:2012, DIN EN 62109-1, EN 50438:2013, G59/3, G83/2, IEC 61727, IEC 62109-1, IEC 62109-2, IEC 62116, NRS 97-2-1, PPC, PPDS, RD 661/2007, RD 1699:2011, SI4777, TOR D4, VDE 0124-100, VDE0126-1-1:2006, VDE0126-1-1 / UTE C15-712-1, VDE-ARN 4105, VFR 2014

* **IT, Delta-IT:** When using in these systems, the grounding conductor monitoring must be deactivated and an additional grounding connected to the inverter.

** **EN 50438:** does not apply to all national appendices of EN 50438

IEC 62109-2: This standard requires that either the multifunction relay in the inverter is used as fault indicator or that the inverter is connected to Sunny Portal and that the fault alert is activated in Sunny Portal.

NRS 97-2-1: This standard requires a separate label attached to the AC distribution board which indicates the AC-side disconnection of the inverter in case of a grid failure (for further details, see NRS 97-2-1, Sect. 4.2.7.1 and 4.2.7.2)

RD 661/2007, RD 1699:2011:Contact the Service for restrictions in specific regions(see Section 13, page 55).

11.3 Protective Devices

DC reverse polarity protection	Short-circuit diode
Input-side disconnection point	Electronic Solar Switch, SUNCLIX DC connector
DC overvoltage protection	Thermally monitored varistors
AC short-circuit current capability	Current control
Grid monitoring	SMA Grid Guard 3
Maximum permissible fuse protection for SB 3000TL-21	25 A

Maximum permissible fuse protection for SB 3600TL-21	32 A
Maximum permissible fuse protection for SB 4000TL-21	32 A
Maximum permissible fuse protection for SB 5000TL-21	32 A
Ground-fault monitoring for SB 3000TL-21	Insulation monitoring: $R_{iso} > 625 \text{ k}\Omega$
Ground-fault monitoring for SB 3600TL-21	Insulation monitoring: $R_{iso} > 550 \text{ k}\Omega$
Ground-fault monitoring for SB 4000TL-21	Insulation monitoring: $R_{iso} > 500 \text{ k}\Omega$
Ground-fault monitoring for SB 5000TL-21	Insulation monitoring: $R_{iso} > 400 \text{ k}\Omega$
All-pole sensitive residual-current monitoring unit	Available

11.4 Climatic Conditions

Installation in accordance with IEC 60721-3-3, Class 4K4H

Extended temperature range	-25 °C to +60 °C
Extended humidity range	0% to 100%
Extended air pressure range	79.5 kPa to 106 kPa

Transport in accordance with IEC 60721-3-2, Class 2K3

Temperature range	-25 °C to +70 °C
-------------------	------------------

11.5 Equipment

DC connection	SUNCLIX DC connector
AC connection	Spring-cage terminal
Display	LC graphic display
BLUETOOTH	As standard
Speedwire/Webconnect data module	As standard
RS485, galvanically isolated	Optional
Multifunction relay	Optional
SMA Power Control Module	Optional

11.6 Torques

Upper enclosure lid screws	6 Nm \pm 0.3 Nm
Lower enclosure lid screws	2 Nm \pm 0.3 Nm

Additional grounding	6.0 Nm
SUNCLIX swivel nut	2.0 Nm
RS485 communication or Speedwire/Webconnect connection	1.5 Nm
Multifunction relay connection	1.5 Nm

11.7 Electronic Solar Switch

Electrical endurance in the event of short circuit, at nominal current of 35 A	At least 50 switching operations
Maximum switching current	35 A
Maximum switching voltage	800 V
Maximum power	12 kW
Degree of protection when plugged in	IP65
Degree of protection when unplugged	IP21
Fuses for Electronic Solar Switch	F200, 600 V/4 A, fast acting and F201, 600 V / 4 A, fast acting (soldered, not replaceable)

11.8 Data Storage Capacity

Energy yields in the course of the day	63 days
Daily yields	30 years
Event messages for users	250 events
Event messages for installers	250 events

12 Accessories

You will find the accessories for your product in the following overview. If required, these can be ordered from SMA Solar Technology AG or your distributor.

Designation	Brief description	SMA order number
RS485 data module	RS485 interface as retrofit kit	DM-485CB-10
SMA Power Control Module	Multifunction interface for implementing grid management systems for one inverter	PWCMOD-10
Multifunction relay	Multifunction relay as retrofit kit	MFR01-10
Fan retrofit kit	Fan to be installed in the inverter for supplementary cooling	FANKIT01-10

13 Contact

If you have technical problems with our products, contact the SMA Service Line. We need the following information in order to provide you with the necessary assistance:

- Inverter device type
- Inverter serial number
- Inverter firmware version
- Special country-specific settings of the inverter (if applicable)
- Type and quantity of PV modules connected
- Mounting location and altitude of the inverter
- Inverter message
- Optional equipment, e.g. communication products
- Operating mode of the multifunction relay (if present)

Australia	SMA Australia Pty Ltd. Sydney	Toll free for Australia: 1800 SMA AUS (1800 762 287) International: +61 2 9491 4200
Belgien/Bel- gique/België	SMA Benelux BVBA/SPRL Mecheln	+32 15 286 730
Brasil	Vide España (Espanha)	
Česko	SMA Central & Eastern Europe s.r.o. Praha	+420 235 010 417
Chile	Ver España	
Danmark	Se Deutschland (Tyskland)	
Deutschland	SMA Solar Technology AG Niestetal	Medium Power Solutions Wechselrichter: +49 561 9522-1499 Kommunikation: +49 561 9522-2499 SMA Online Service Center: www.SMA.de/Service
		Hybrid Energy Solutions Sunny Island: +49 561 9522-399 PV-Diesel Hybridsysteme: +49 561 9522-3199
		Power Plant Solutions Sunny Central: +49 561 9522-299
España	SMA Ibérica Tecnología Solar, S.L.U. Barcelona	Llamada gratuita en España: 900 14 22 22 Internacional: +34 902 14 24 24

France	SMA France S.A.S. Lyon	Medium Power Solutions Onduleurs : +33 472 09 04 40 Communication : +33 472 09 04 41
		Hybrid Energy Solutions Sunny Island : +33 472 09 04 42
		Power Plant Solutions Sunny Central : +33 472 09 04 43
India	SMA Solar India Pvt. Ltd. Mumbai	+91 22 61713888
Italia	SMA Italia S.r.l. Milano	+39 02 8934-7299
Κύπρος/Kypris	Βλέπε Ελλάδα/ Bkz. Ελλάδα (Yunanistan)	
Luxemburg/ Luxembourg	Siehe Belgien Voir Belgique	
Magyarország	lásd Česko (Csehország)	
Nederland	zie Belgien (België)	
Österreich	Siehe Deutschland	
Perú	Ver España	
Polska	Patrz Česko (Czechy)	
Portugal	SMA Solar Technology Portugal, Unipessoal Lda Lisboa	Gratuito em Portugal: 800 20 89 87 Internacional: +351 212377860
România	Vezi Česko (Cehia)	
Schweiz	Siehe Deutschland	
Slovensko	pozri Česko (Česká republika)	
South Africa	SMA Solar Technology South Africa Pty Ltd. Centurion (Pretoria)	08600 SUNNY (08600 78669) International: +27 (12) 643 1785
United King- dom	SMA Solar UK Ltd. Milton Keynes	+44 1908 304899
Ελλάδα	SMA Hellas AE Αθήνα	801 222 9 222 International: +30 212 222 9 222
България	Вижте Ελλάδα (Гърция)	

ไทย	SMA Solar (Thailand) Co., Ltd. กรุงเทพฯ	+66 2 670 6999	
대한민국	SMA Technology Korea Co., Ltd. 서울	+82-2-520-2666	
+971 2 234-6177	SMA Middle East LLC أبو ظبي		الإمارات العربية المتحدة
Other countries	International SMA Service Line Niestetal	Toll free worldwide: 00800 SMA SERVICE (+800 762 7378423)	

14 EC Declaration of Conformity

within the meaning of the EC directives

- 2004/108/EG (Electromagnetic compatibility, EMC)
- 2006/95/EG (Low voltage directive)
- 1999/5/EC (Radio and Telecommunications Terminal Equipment, R&TTE)

SMA Solar Technology AG confirms herewith that the inverters described in this document are in compliance with the fundamental requirements and other relevant provisions of the above-mentioned directives. The entire EC Declaration of Conformity can be found at www.SMA-Solar.com.



SMA Solar Technology

www.SMA-Solar.com

