

Operating Manual

**SUNNY TRIPOWER 15000TL / 20000TL /
25000TL**

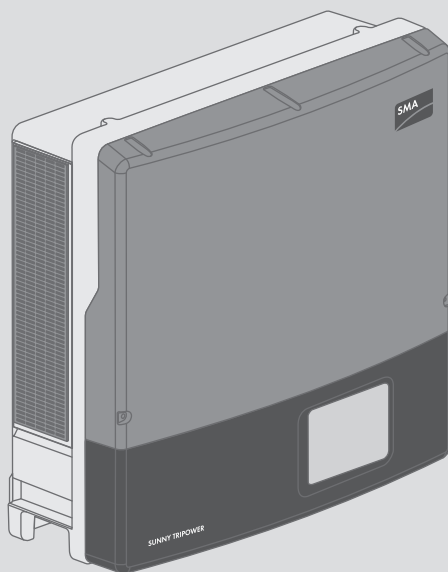

Legal Provisions

The information contained in these documents is property of SMA Solar Technology AG. Any publication, whether in whole or in part, requires prior written approval by SMA Solar Technology AG. Internal reproduction used solely for the purpose of product evaluation or other proper use is allowed and does not require prior approval.

SMA Warranty

You can download the current warranty conditions from the Internet at www.SMA-Solar.com.

Trademarks

All trademarks are recognized, even if not explicitly identified as such. Missing designations do not mean that a product or brand is not a registered trademark.

Modbus® is a registered trademark of Schneider Electric and is licensed by the Modbus Organization, Inc.

QR Code is a registered trademark of DENSO WAVE INCORPORATED.

Phillips® and Pozidriv® are registered trademarks of Phillips Screw Company.

Torx® is a registered trademark of Acument Global Technologies, Inc.

SMA Solar Technology AG

Sonnenallee 1

34266 Niestetal

Germany

Tel. +49 561 9522-0

Fax +49 561 9522-100

www.SMA.de

Email: info@SMA.de

Copyright © 2016 SMA Solar Technology AG. All rights reserved.

Table of Contents

1	Information on this Document	5
1.1	Validity	5
1.2	Target group	5
1.3	Additional Information.....	5
1.4	Symbols.....	6
1.5	Nomenclature	7
2	Safety	8
2.1	Intended Use.....	8
2.2	Safety Information	8
3	Scope of Delivery	10
4	Product Description	11
4.1	Sunny Tripower.....	11
4.2	Interfaces and Functions.....	13
5	Mounting.....	16
5.1	Requirements for Mounting.....	16
5.2	Mounting the Inverter	18
6	Electrical Connection	21
6.1	Safety during Electrical Connection	21
6.2	Overview of the Connection Area.....	22
6.2.1	View from Below.....	22
6.2.2	Interior View	23
6.3	AC Connection	23
6.3.1	Requirements for the AC Connection	23
6.3.2	Connecting the Inverter to the Utility Grid	25
6.3.3	Connecting Additional Grounding	27
6.4	DC Connection	28
6.4.1	Requirements for the DC Connection	28
6.4.2	Connecting the PV Array.....	28
7	Commissioning	31
7.1	Commissioning Procedure.....	31

7.2	Configuring the Country Data Set	31
7.3	Commissioning the Inverter	32
8	Configuration	35
8.1	Configuration Procedure	35
8.2	Integrating the Inverter into the Network	35
8.3	Changing Operating Parameters	36
8.4	Setting the Active Power Limitation in case of PV System Control Failure	36
8.5	Configuring the Modbus Function	37
8.6	Reducing the Attenuation of Ripple Control Signals	37
8.7	Setting SMA OptiTrac Global Peak	38
9	Operation	39
9.1	LED Signals	39
9.2	Display Overview	39
9.3	Activating and Operating the Display	41
9.4	Calling Up Display Messages of the Start-Up Phase	42
10	Disconnecting the Inverter from Voltage Sources	43
11	Technical Data	46
12	Accessories	51
13	Contact	52
14	EU Declaration of Conformity	54

1 Information on this Document

1.1 Validity

This document is valid for the following device types:

- STP 15000TL-30 (Sunny Tripower 15000TL)
- STP 20000TL-30 (Sunny Tripower 20000TL)
- STP 25000TL-30 (Sunny Tripower 25000TL)

1.2 Target group

This document is intended for qualified persons and end users. Only qualified persons are allowed to perform the activities marked in this document with a warning symbol and the caption "Qualified person". Tasks that do not require any particular qualification are not marked and can also be performed by end users. Qualified persons must have the following skills:

- Knowledge of how an inverter works and is operated
- Training in how to deal with the dangers and risks associated with installing and using electrical devices and installations
- Training in the installation and commissioning of electrical devices and installations
- Knowledge of the applicable standards and directives
- Knowledge of and compliance with this document and all safety information



1.3 Additional Information





Links to additional information can be found at www.SMA-Solar.com:

Document title and content	Document type
Troubleshooting, cleaning, replacement of surge arresters type II and decommissioning	Service Manual
"Application for SMA Grid Guard Code"	Form
"SMA Speedwire/Webconnect Data Module" Connection to the Speedwire/Webconnect data module	Installation Manual
"Webconnect Systems in Sunny Portal" Registration in Sunny Portal and setting or changing operating parameters of the inverter	User Manual
"Overview of the Rotary Switch Settings" Overview of the rotary switch settings for configuring the country data set and display language	Technical Information
"Efficiency and Derating" Efficiency and Derating Behavior of the Sunny Boy, Sunny Tripower and Sunny Mini Central Inverters	Technical Information

Document title and content	Document type
"Criteria for Selecting a Residual-Current Device"	Technical Information
"Circuit Breaker" Dimensioning and Selection of a Suitable AC Circuit Breaker for Inverters under PV-Specific Influences	Technical Information
"Insulation Resistance (Riso) of Non-Galvanically Isolated PV Systems" Calculating the insulation resistance for troubleshooting	Technical Information
"Integrated Plant Control and Q on Demand 24/7" Detailed explanation of functions and description for setting the functions	Technical Information
"Shade Management" Efficient operation of partly shaded PV systems with Opti-Trac Global Peak	Technical Information
"Leading Leakage Currents" Information on the Design of Transformerless Inverters	Technical Information
"Firmware Update with SD Card"	Technical Description
"Parameter list" Overview of All Inverter Operating Parameters and Their Configuration Options	Technical Information
"SMA Modbus® Interface" Information on the commissioning and configuration of the SMA Modbus interface	Technical Information
"SMA Modbus® Interface" List with the product specific SMA Modbus registers	Technical Information
"SunSpec® Modbus® Interface" Information on the commissioning and configuration of the SunSpec Modbus interface	Technical Information
"SunSpec® Modbus® Interface" List with the product specific SunSpec Modbus registers	Technical Information

1.4 Symbols

Symbol	Explanation
 DANGER	Indicates a hazardous situation which, if not avoided, will result in death or serious injury
 WARNING	Indicates a hazardous situation which, if not avoided, can result in death or serious injury

Symbol	Explanation
 CAUTION	Indicates a hazardous situation which, if not avoided, can result in minor or moderate injury
NOTICE	Indicates a situation which, if not avoided, can result in property damage
 QUALIFIED PERSON	Sections describing activities to be performed by qualified persons only
	Information that is important for a specific topic or goal, but is not safety-relevant
<input type="checkbox"/>	Indicates a requirement for meeting a specific goal
<input checked="" type="checkbox"/>	Desired result
	A problem that might occur

1.5 Nomenclature

Complete designation	Designation in this document
Sunny Tripower	Inverter, product

2 Safety

2.1 Intended Use

The Sunny Tripower is a transformerless PV inverter with two MPP trackers which converts the direct current of the PV array to grid-compliant three-phase current and feeds it into the utility grid.

The product is suitable for indoor and outdoor use.

The product must only be operated with PV arrays of protection class II in accordance with IEC 61730, application class A. The PV modules must be compatible with this product.

PV modules with a high capacity to ground must only be used if their coupling capacity does not exceed 3.5 μF (for information on how to calculate the coupling capacity, see the Technical Information "Leading Leakage Currents" at www.SMA-Solar.com).

All components must remain within their permitted operating ranges at all times.

The product must only be used in countries for which it is approved or released by SMA Solar Technology AG and the grid operator.

The product is also approved for the Australian market and may be used in Australia. If DRM support is specified, the inverter may only be used in conjunction with a Demand Response Enabling Device (DRED). This ensures that the inverter implements the commands from the grid operator for active power limitation at all times. The inverter and the Demand Response Enabling Device (DRED) must be connected in the same network and the inverter Modbus interface must be activated and the TCP server set.

Use this product only in accordance with the information provided in the enclosed documentation and with the locally applicable standards and directives. Any other application may cause personal injury or property damage.

Alterations to the product, e.g. changes or modifications, are only permitted with the express written permission of SMA Solar Technology AG. Unauthorized alterations will void guarantee and warranty claims and in most cases terminate the operating license. SMA Solar Technology AG shall not be held liable for any damage caused by such changes.

Any use of the product other than that described in the Intended Use section does not qualify as appropriate.

The enclosed documentation is an integral part of this product. Keep the documentation in a convenient place for future reference and observe all instructions contained therein.

The type label must remain permanently attached to the product.

2.2 Safety Information

This section contains safety information that must be observed at all times when working on or with the product.

To prevent personal injury and property damage and to ensure long-term operation of the product, read this section carefully and observe all safety information at all times.

⚠ DANGER**Danger to life due to high voltages of the PV array**

When exposed to sunlight, the PV array generates dangerous DC voltage which is present in the DC conductors and the live components of the inverter. Touching the DC conductors or the live components can lead to lethal electric shocks. If you disconnect the DC connectors from the inverter under load, an electric arc may occur leading to electric shock and burns.

- Do not touch non-insulated cable ends.
- Do not touch the DC conductors.
- Do not touch any live components of the inverter.
- Have the inverter mounted, installed and commissioned only by qualified persons with the appropriate skills.
- If an error occurs, have it rectified by qualified persons only.
- Prior to performing any work on the inverter, disconnect it from all voltage sources as described in this document (see Section 10 "Disconnecting the Inverter from Voltage Sources", page 43).

⚠ DANGER**Danger to life due to electric shock**

Touching an ungrounded PV module or array frame can cause a lethal electric shock.

- Connect and ground the PV modules, array frame and electrically conductive surfaces so that there is continuous conduction. Observe the applicable local regulations.

⚠ CAUTION**Risk of burns due to hot enclosure parts**

Some parts of the enclosure can get hot during operation.

- Do not touch any parts other than the lower enclosure lid of the inverter during operation.

NOTICE**Damage to seals on the enclosure lids in subfreezing conditions**

If you open the upper and lower enclosure lids when temperatures are below freezing, the enclosure seals can be damaged. This can lead to moisture entering the inverter.

- Do not open the inverter at ambient temperatures lower than -5°C .
- If a layer of ice has formed on the seal of the lid when temperatures are below freezing, remove it prior to opening the enclosure lids of the inverter (e.g. by melting the ice with warm air). Observe the applicable safety regulations.

3 Scope of Delivery

Check the scope of delivery for completeness and any externally visible damage. Contact your distributor if the scope of delivery is incomplete or damaged.

The delivery may contain parts that are not required for the installation of this inverter.

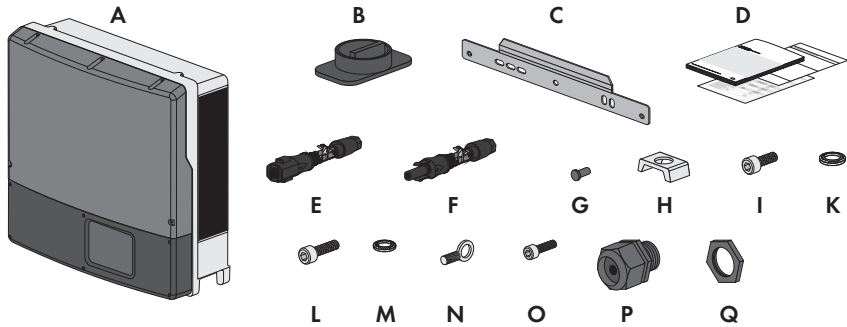

Figure 1: Components included in the scope of delivery

Position	Quantity	Designation
A	1	Inverter
B	1	DC load-break switch
C	1	Wall mounting bracket
D	1	Quick installation guide, supplementary sheet with default settings, installation manual of the DC connectors
E	6	Negative DC connector
F	6	Positive DC connector
G	12	Sealing plug
H	1	Clamping bracket
I	1	Cylindrical screw M6 x 16
K	1	Conical spring washer M6
L	2	Cylindrical screw M5 x 20*
M	2	Conical spring washer M5*
N	1	Eye bolt M8
O	2	Cylindrical screw M5 x 10
P	1	AC cable gland
Q	1	Counter nut

* Spare part for the enclosure lid

4 Product Description

4.1 Sunny Tripower

The Sunny Tripower is a transformerless PV inverter with two MPP trackers which converts the direct current of the PV array to grid-compliant three-phase current and feeds it into the utility grid.

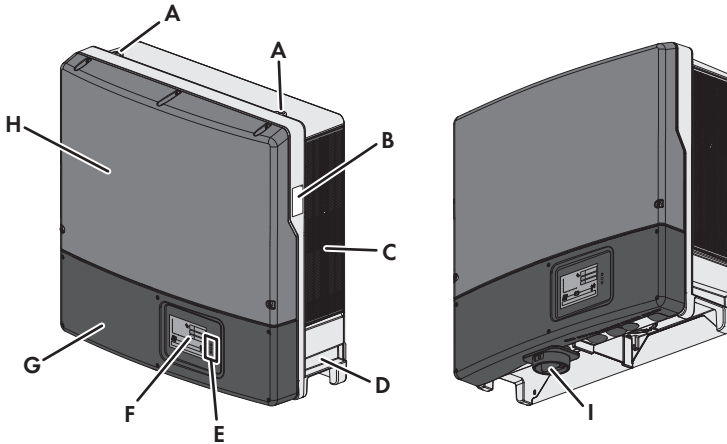

















Figure 2: Design of the Sunny Tripower

Position	Designation
A	Thread for screwing in two eye bolts for transport
B	Type label The type label uniquely identifies the inverter. You will require the information on the type label to use the product safely and when seeking customer support from the SMA Service Line. You will find the following information on the type label: <ul style="list-style-type: none"> • Device type (Model) • Serial number (Serial No.) • Date of manufacture • Device-specific characteristics
C	Ventilation grid
D	Recessed grip
E	LEDs The LEDs indicate the operating state of the inverter (see Section 9.1 "LED Signals", page 39).

Position	Designation
F	Display (optional) The display shows the current operating data and events or errors (see service manual at www.SMA-Solar.com).
G	Lower enclosure lid
H	Upper enclosure lid
I	DC load-break switch The inverter is equipped with a DC load-break switch. If the DC load-break switch is set to the position I , it establishes a conductive connection between the PV array and the inverter. Setting the DC load-break switch to the O position interrupts the DC electric circuit and completely disconnects the PV array from the inverter. Disconnection takes place at all poles.

Symbols on the Inverter and on the Type Label

Symbol	Explanation
	Inverter Together with the green LED, this symbol indicates the operating state of the inverter.
	Observe the documentation Together with the red LED, this symbol indicates an error (for troubleshooting, see the service manual at www.SMA-Solar.com).
	BLUETOOTH No function. The inverter is equipped with Speedwire/Webconnect.
	Danger This symbol indicates that the inverter must be additionally grounded if a second grounding conductor or equipotential bonding is required locally (see Section 6.3.3 "Connecting Additional Grounding", page 27).
	Danger to life due to electric shock The product operates at high voltages. All work on the product must be carried out by qualified persons only.
	Risk of burns due to hot surfaces The product can get hot during operation. Avoid contact during operation. Allow the product to cool down sufficiently before carrying out any work.
	Observe the documentation Observe all documentation supplied with the product.

Symbol	Explanation
	Direct current
	The product does not have a transformer.
	Three-phase alternating current with neutral conductor
	WEEE designation Do not dispose of the product together with the household waste but in accordance with the locally applicable disposal regulations for electronic waste.
	CE marking The product complies with the requirements of the applicable EU directives.
	Degree of protection IP65 The product is protected against dust intrusion and water jets from any angle.
	The product is suitable for outdoor installation.
	RCM (Regulatory Compliance Mark) The product complies with the requirements of the applicable Australian standards.

4.2 Interfaces and Functions

The inverter can be equipped or retrofitted with the following interfaces and functions:

SMA Speedwire/Webconnect

The inverter is equipped with SMA Speedwire/Webconnect as standard. SMA Speedwire/Webconnect is a type of communication based on the Ethernet standard. This enables inverter-optimized 10/100 Mbit data transmission between Speedwire devices in PV systems and the software Sunny Explorer. The Webconnect function enables direct data transmission between the inverters of a small-scale system and the Internet portal Sunny Portal without any additional

communication device and for a maximum of 4 inverters per Sunny Portal system. In large-scale PV power plants, data transmission to the Internet portal Sunny Portal is carried out via the SMA Cluster Controller. You can access your Sunny Portal system from any computer with an Internet connection.

Webconnect enables - for PV systems operated in Italy - the connection or disconnection of the inverter to or from the utility grid and the specifying of the frequency limits to be used via IEC61850-GOOSE messages.

RS485 Interface

The inverter can communicate via cables with special SMA communication products via the RS485 interface (information on supported SMA products at www.SMA-Solar.com). The RS485 interface can be retrofitted and can be used in place of the SMA Speedwire/Webconnect interface in the inverter.

Modbus

The inverter is equipped with a Modbus interface. The Modbus interface is deactivated by default and must be configured as needed.

The Modbus interface of the supported SMA devices is designed for industrial use and has the following tasks:

- Remote query of measured values
- Remote setting of operating parameters
- Setpoint specifications for system control

Grid Management Services

The inverter is equipped with service functions for grid management.

Depending on the requirements of the grid operator, you can activate and configure the functions (e.g. active power limitation) via operating parameters.

SMA Power Control Module

The SMA Power Control Module enables the inverter to implement grid management services and is equipped with an additional multifunction relay (for information on installation and configuration, see the installation manual of the SMA Power Control Module). The SMA Power Control Module can be retrofitted.

Multifunction Relay

You can configure the multifunction relay for various operating modes. The multifunction relay is used, for example, to switch fault indicators on or off (for information on installation and configuration, see the installation manual of the multifunction relay). The multifunction relay can be retrofitted.

SMA OptiTrac Global Peak

SMA OptiTrac Global Peak is an advancement of SMA OptiTrac and allows the operating point of the inverter to follow the optimal operating point of the PV array (MPP) precisely at all times. In addition, with the aid of SMA OptiTrac Global Peak, the inverter detects several maximum power points in the available operating range, such as may occur particularly with partially shaded strings. SMA OptiTrac Global Peak is enabled by default.

Surge arrester type II

Surge arresters limit dangerous overvoltages. Surge arresters of type II can be retrofitted (for details on the installation refer to the service manual of the inverter at www.SMA-Solar.com).

Q on Demand 24/7

The inverter can supply reactive power by means of Q on Demand 24/7 covering the entire unit circle around the clock (for details on the configuration refer to the Technical Information "Integrated Plant Control and Q on Demand 24/7" at www.SMA-Solar.com).

Integrated Plant Control

The inverter can display the Q(V) characteristic curve specified by the grid operator by means of Integrated Plant Control without measuring on the grid-connection point. The inverter can automatically compensate equipment installed between the inverter and the grid-connection point after having activated the function (for information on the system configuration refer to the Technical Information "Integrated Plant Control and Q on Demand 24/7" at www.SMA-Solar.com).

5 Mounting

5.1 Requirements for Mounting

Requirements for the mounting location:

⚠ WARNING

Danger to life due to fire or explosion

Despite careful construction, electrical devices can cause fires.

- Do not mount the inverter in areas containing highly flammable materials or gases.
- Do not mount the inverter in a potentially explosive atmosphere.

- Do not mount the inverter on a pillar.
- The mounting location must be inaccessible to children.
- A solid support surface must be available for mounting, e.g. concrete or masonry. When mounted on drywall or similar materials, the inverter emits audible vibrations during operation which could be perceived as annoying.
- The mounting location must be suitable for the weight and dimensions of the inverter (see Section 11 "Technical Data", page 46).
- The mounting location must not be exposed to direct solar irradiation. Direct solar irradiation can result in the premature aging of the exterior plastic parts of the inverter and direct solar irradiation can cause the inverter to overheat. When becoming too hot, the inverter reduces its power output to avoid overheating.
- The mounting location should be freely and safely accessible at all times without the need for any auxiliary equipment (such as scaffolding or lifting platforms). Non-fulfillment of these criteria may restrict servicing.
- To ensure optimum operation, the ambient temperature should be between -25°C and 40°C .
- Climatic conditions must be met (see Section 11 "Technical Data", page 46).

Permitted and prohibited mounting positions:

- The inverter must only be mounted in one of the permitted positions. This will ensure that no moisture can penetrate the inverter.
- The inverter should be mounted in such a way that LED signals can be read without difficulty.

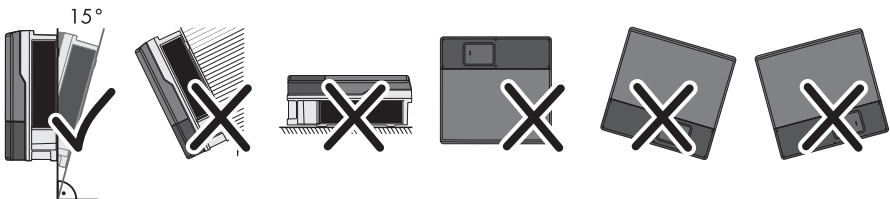

Figure 3: Permitted and prohibited mounting positions:

Dimensions for mounting:

Figure 4: Position of the anchoring points

Recommended clearances:

If you maintain the recommended clearances, adequate heat dissipation will be ensured. Thus, you will prevent power reduction due to excessive temperature.

- Maintain the recommended clearances to walls as well as to other inverters or objects.
- If multiple inverters are mounted in areas with high ambient temperatures, increase the clearances between the inverters and ensure sufficient fresh-air supply.

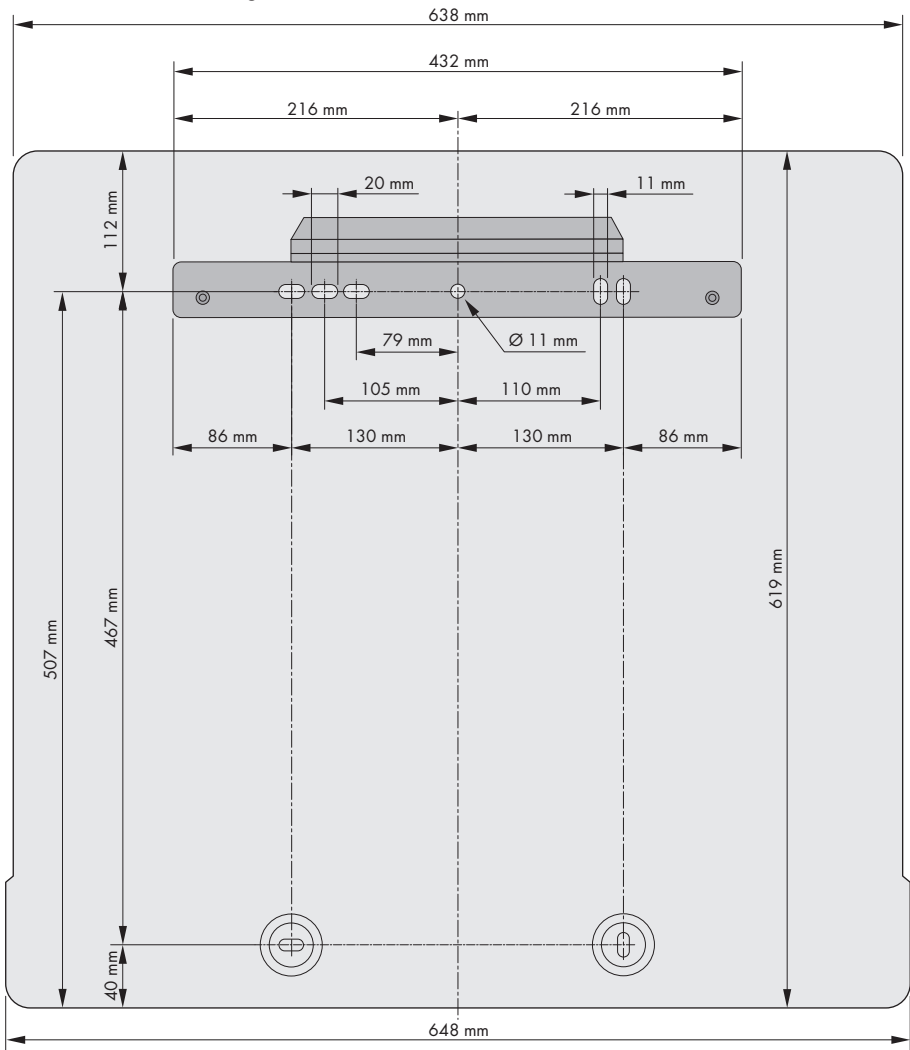
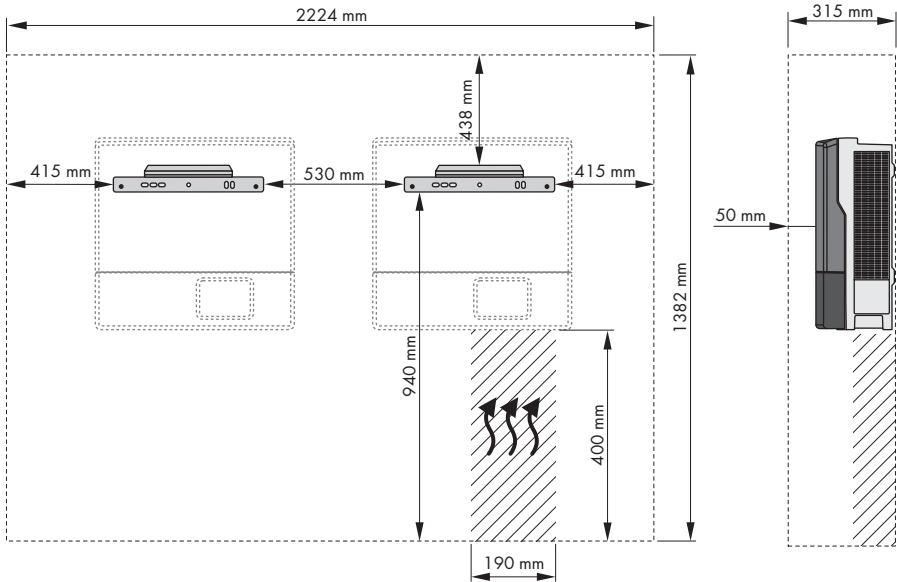

Figure 5: Recommended clearances

5.2 Mounting the Inverter

Additionally required mounting material (not included in the scope of delivery):

- At least two screws suitable for the support surface (diameter: 10 mm at maximum)
- At least two washers that are suitable for the screws (diameter: 30 mm at maximum)
- If necessary, two screw anchors suitable for the support surface and the screws
- For transporting the inverter with a crane: two eye bolts suitable for the weight of the inverter (size: M10)
- To secure the inverter from being lifted off: two screws suitable for the support surface, two washers suitable for the screws and - depending on the support surface - two screw anchors suitable for the support surface and the screws

⚠ CAUTION

Risk of injury when lifting the inverter, or if it is dropped

The inverter weighs 61 kg. There is risk of injury if the inverter is lifted incorrectly or dropped while being transported or when attaching it to or removing it from the wall mounting bracket.

- Carry and lift the inverter in an upright position with several people without tilting it. With one hand grasp the recessed grip, and with the other hand support the top part of the enclosure. This will prevent the inverter tipping forward.
- If the inverter is to be transported and lifted with a crane, remove the filler plugs on the top of the inverter and screw the eye bolts into the threads.

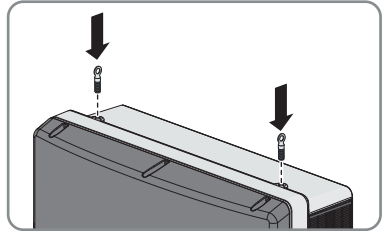
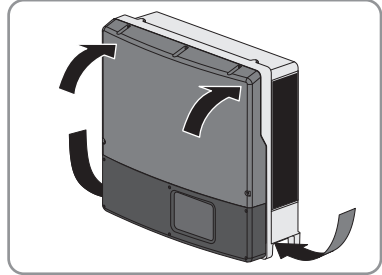

⚠ CAUTION

Risk of burns due to hot enclosure parts

Some parts of the enclosure can get hot during operation.

- Mount the inverter in such a way that it cannot be touched inadvertently during operation.

Procedure:

1. ⚠ CAUTION

Risk of injury due to damaged cables

There may be power cables or other supply lines (e.g. gas or water) routed in the wall.

- Ensure that no lines are laid in the wall which could be damaged when drilling holes.
2. Align the wall mounting bracket horizontally on the wall and use it to mark the position of the drill holes. Use at least one hole on the right-hand and left-hand side in the wall mounting bracket.
 3. If the inverter is to be secured from being lifted off of the wall mounting bracket, mark the position of the drill holes for the screw that attaches the inverter to the wall mounting bracket. Observe the dimensions of the two anchoring points at the bottom of the inverter rear panel.
 4. Set the wall mounting bracket aside and drill the marked holes.

5. Insert screw anchors into the drill holes if the support surface requires them.
6. Secure the wall mounting bracket horizontally using screws and washers.
7. Hook the inverter into the wall mounting bracket.

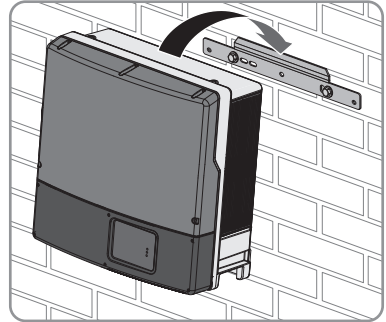

8. If the inverter has been transported with a crane, remove the eye bolts from the threads on the top of the inverter and reinsert the filler plugs.
9. Remove all six screws from the lower enclosure lid using an Allen key (AF 3).

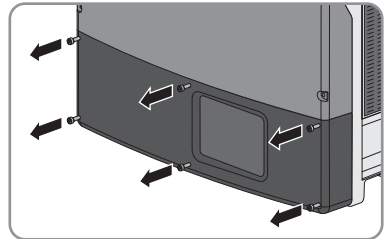

10. Flip the lower enclosure lid up and remove it.

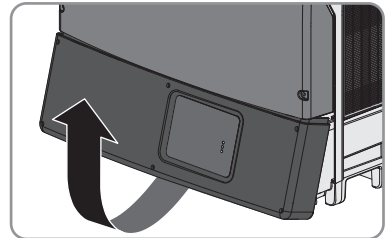

11. In order to secure the inverter from being lifted off the wall accidentally, attach it to the wall with suitable mounting material. Use both of the lower drill holes on the rear panel of the inverter.

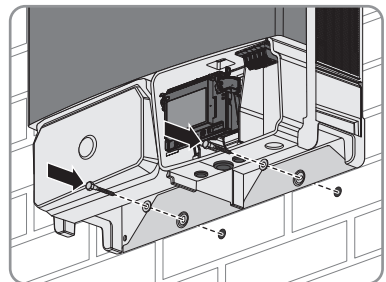

12. Ensure that the inverter is securely in place.

6 Electrical Connection

6.1 Safety during Electrical Connection

⚠ DANGER

Danger to life due to high voltages of the PV array

When exposed to sunlight, the PV array generates dangerous DC voltage which is present in the DC conductors and the live components of the inverter. Touching the DC conductors or the live components can lead to lethal electric shocks. If you disconnect the DC connectors from the inverter under load, an electric arc may occur leading to electric shock and burns.

- Do not touch non-insulated cable ends.
- Do not touch the DC conductors.
- Do not touch any live components of the inverter.
- Have the inverter mounted, installed and commissioned only by qualified persons with the appropriate skills.
- If an error occurs, have it rectified by qualified persons only.
- Prior to performing any work on the inverter, disconnect it from all voltage sources as described in this document (see Section 10 "Disconnecting the Inverter from Voltage Sources", page 43).

NOTICE

Damage to seals on the enclosure lids in subfreezing conditions

If you open the upper and lower enclosure lids when temperatures are below freezing, the enclosure seals can be damaged. This can lead to moisture entering the inverter.

- Do not open the inverter at ambient temperatures lower than -5°C .
- If a layer of ice has formed on the seal of the lid when temperatures are below freezing, remove it prior to opening the enclosure lids of the inverter (e.g. by melting the ice with warm air). Observe the applicable safety regulations.

NOTICE

Damage to the inverter due to electrostatic discharge

Touching electronic components can cause damage to or destroy the inverter through electrostatic discharge.

- Ground yourself before touching any component.

6.2 Overview of the Connection Area

6.2.1 View from Below

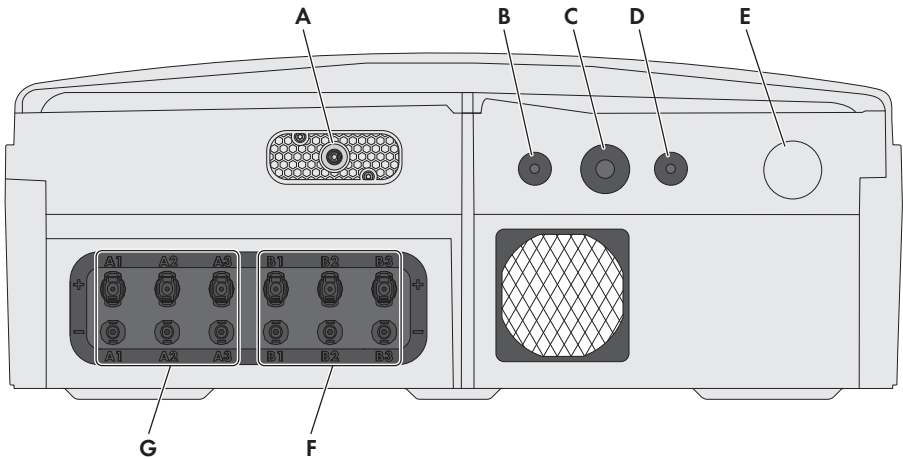

Figure 6: Enclosure openings at the bottom of the inverter

Position	Designation
A	Pin connector for the DC load-break switch
B	Enclosure opening M20 with filler plug for the connection cable of the multi-function relay or SMA Power Control Module
C	Enclosure opening M32 with filler plug for the data cables or network cables
D	Enclosure opening M20 with filler plug for the data cables or network cables
E	Enclosure opening for the AC connection
F	Positive and negative DC connectors, input B
G	Positive and negative DC connectors, input A

6.2.2 Interior View

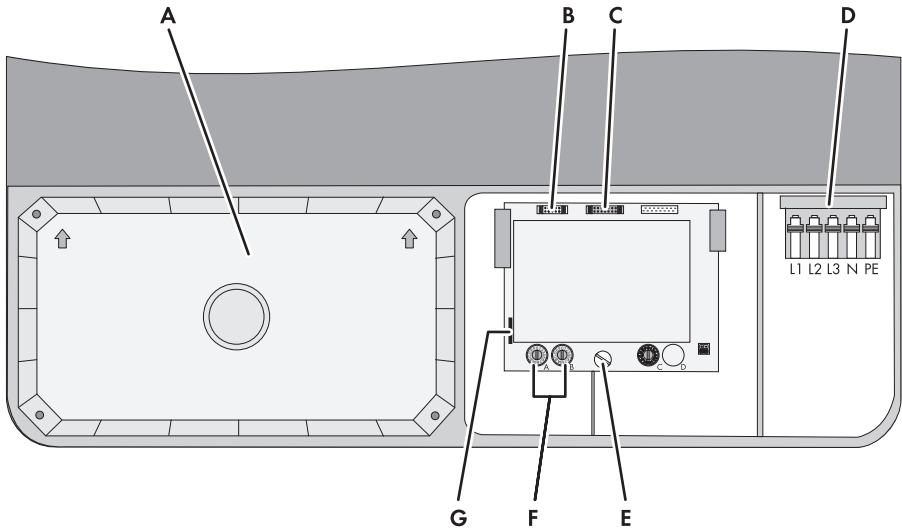

Figure 7: Connection areas in the interior of the inverter

Position	Designation
A	DC protective cover
B	Pin connector for connecting the multifunction relay or the SMA Power Control Module
C	Pin connector for connecting the communication interface
D	Connecting terminal plate for connecting the AC cable
E	Screw to release and attach the communication board
F	Rotary switch A and B for setting the country data set
G	Slot for the SD memory card (for service purposes)

6.3 AC Connection

6.3.1 Requirements for the AC Connection

Cable requirements:

- The conductors must consist of copper.
- External diameter: 14 mm to 25 mm
- Conductor cross-section: 6 mm² to 16 mm²
- Maximum conductor cross-section with bootlace ferrule: 10 mm²

- Insulation stripping length: 12 mm
- The cable must be dimensioned in accordance with the local and national directives for the dimensioning of cables. The requirements for the minimum wire size derive from these directives. Examples of factors influencing cable dimensioning are: nominal AC current, type of cable, routing method, cable bundling, ambient temperature and maximum desired line losses (for calculation of line losses, see the design software "Sunny Design" from software version 2.0 at www.SMA-Solar.com).

Load-break switch and cable protection:

NOTICE

Damage to the inverter due to the use of screw-type fuses as load-break switches

Screw-type fuses (e.g. DIAZED fuse or NEOZED fuse) are not load-break switches.

- Do not use screw-type fuses as load-break switches.
- Use a load-break switch or circuit breaker as a load disconnection unit (for information and design examples, see the Technical Information "Circuit Breaker" at www.SMA-Solar.com).

- In PV systems with multiple inverters, protect each inverter with a separate three-phase circuit breaker. Make sure to observe the maximum permissible fuse protection (see Section 1.1 "Technical Data", page 46). This will prevent residual voltage being present at the corresponding cable after disconnection.
- Loads installed between the inverter and the circuit breaker must be fused separately.

Residual-current monitoring unit:

- If an external residual-current device is required, install a residual-current device which trips at a residual current of 100 mA or higher (for details on selecting a residual-current device, see the Technical Information "Criteria for Selecting a Residual-Current Device" at www.SMA-Solar.com).

Overvoltage category:

The inverter can be used in grids of overvoltage category III or lower in accordance with IEC 60664-1. That means that the inverter can be permanently connected to the grid-connection point of a building. In case of installations with long outdoor cabling routes, additional measures to reduce overvoltage category IV to overvoltage category III are required (see the Technical Information "Overvoltage Protection" at www.SMA-Solar.com).

Additional grounding:

i Safety in accordance with IEC 62109

The inverter is not equipped with a grounding conductor monitoring device. In order to guarantee safety in accordance with IEC 62109, you must take one of the following measures:

- Connect a grounding conductor made of copper wire with a cross-section of at least 10 mm² to the connecting terminal plate for the AC cable.
- Connect additional grounding with the same cross-section as the connected grounding conductor to the connecting terminal plate for the AC cable (see Section 6.3.3 "Connecting Additional Grounding", page 27). This prevents touch current if the grounding conductor at the connecting terminal plate for the AC cable fails.

i Connection of additional grounding

In some countries, additional grounding is generally required. In each case, observe the locally applicable regulations.

- If additional grounding is required, connect an additional grounding that has at least the same cross-section as the connected grounding conductor to the connecting terminal plate for the AC cable (see Section 6.3.3, page 27). This prevents touch current if the grounding conductor at the connecting terminal plate for the AC cable fails.

6.3.2 Connecting the Inverter to the Utility Grid

Requirements:

- The connection requirements of the grid operator must be met.
- The grid voltage must be in the permissible range. The exact operating range of the inverter is specified in the operating parameters.

Procedure:

1. Disconnect the circuit breaker from all three line conductors and secure against reconnection.
2. If the lower enclosure lid is mounted, loosen all screws of the lower enclosure lid using an Allen key (AF 3) and lift the enclosure lid from below and remove it.
3. Remove the adhesive tape from the enclosure opening for the AC cable.

4. Insert the cable gland from the outside into the enclosure opening and tighten it from the inside with the counter nut.

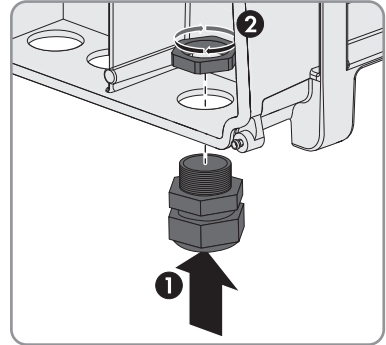

5. Route the AC cable into the inverter through the cable gland. If necessary, slightly loosen the swivel nut of the cable gland.
6. Dismantle the AC cable.
7. Shorten L1, L2, L3 and N by 5 mm each so that PE is 5 mm longer.
8. Strip off the insulation of L1, L2, L3, N and PE by 12 mm.
9. Push the safety levers of the AC connecting terminal plate right up to the stop.

10. **⚠ CAUTION**

Risk of fire if two conductors are connected to one terminal

If you connect two conductors to a terminal, a fire can occur due to a bad electrical connection.

- Never connect more than one conductor per terminal.

11. **⚠ CAUTION**

Danger of crushing when locking levers snap shut

The locking levers close by snapping down fast and hard.

- Press the locking levers of the connecting terminal plate for the AC cable down with your thumb only.
- Do not grip the entire connecting terminal plate for the AC cable.
- Do not place your fingers under the locking levers.

12. Connect PE, N, L1, L2 and L3 according to the labeling to the connecting terminal plate for the AC cable and push the safety levers down. The direction of the rotating magnetic field of L1, L2 and L3 is not relevant.
13. Make sure that all conductors are securely in place.

14. Tighten the swivel nut of the cable gland.

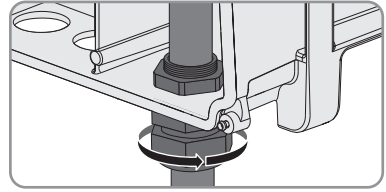

6.3.3 Connecting Additional Grounding

If additional grounding or equipotential bonding is required locally, you can connect additional grounding to the inverter. This prevents touch current if the grounding conductor at the terminal for the AC cable fails. The required clamping bracket, the screw and the conical spring washer are part of the scope of delivery of the inverter.

Cable requirement:

Use of fine-stranded conductors

You can use an inflexible or a flexible, fine-stranded conductor.

- When using a fine-stranded conductor, it has to be double crimped by a ring terminal lug. Make sure that no insulated conductor is visible when pulling or bending. This will ensure sufficient strain relief by means of the ring terminal lug.

Grounding cable cross-section: 16 mm² at maximum

Procedure:

1. Strip the grounding cable insulation.
2. Lead the clamping bracket over the grounding cable. Arrange the grounding cable on the left-hand side.

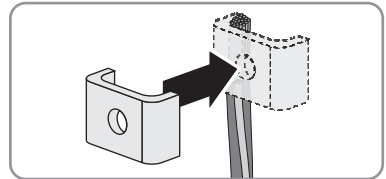

3. Screw the clamping bracket tight using the M6x16 cylindrical screw and the conical spring washer M6 (torque: 6 Nm). The teeth of the conical spring washer must face the clamping bracket.

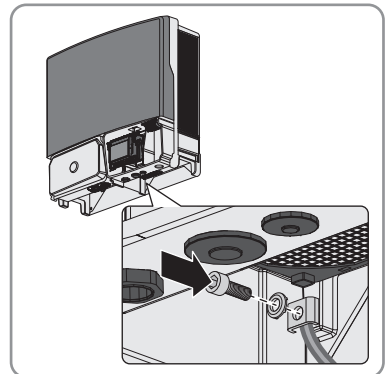

6.4 DC Connection

6.4.1 Requirements for the DC Connection

Requirements for the PV modules per input:

- All PV modules must be of the same type.
- All PV modules must be aligned and tilted identically.
- On the coldest day based on statistical records, the open-circuit voltage of the PV array must never exceed the maximum input voltage of the inverter.
- The same number of series-connected PV modules must be connected to each string.
- The maximum input current per string must be maintained and must not exceed the through-fault current of the DC connectors (see Section 11 "Technical Data", page 46).
- The thresholds for the input voltage and the input current of the inverter must be adhered to (see Section 11 "Technical Data", page 46).
- The positive connection cables of the PV modules must be fitted with the positive DC connectors (for information on assembling DC connectors, see the DC connector installation manual).
- The negative connection cables of the PV modules must be fitted with the negative DC connectors (for information on assembling DC connectors, see the DC connector installation manual).

i Use of Y adapters for parallel connection of strings

The Y adapters must not be used to interrupt the DC circuit.

- Do not use the Y adapters in the immediate vicinity of the inverter. The adapters must not be visible or freely accessible.
- In order to interrupt the DC circuit, always disconnect the inverter as described in this document (see Section 10, page 43).

6.4.2 Connecting the PV Array

NOTICE

Destruction of the inverter due to overvoltage

If the open-circuit voltage of the PV modules exceeds the maximum input voltage of the inverter, the inverter can be destroyed due to overvoltage.

- If the open-circuit voltage of the PV modules exceeds the maximum input voltage of the inverter, do not connect any strings to the inverter and check the design of the PV system.

NOTICE

Destruction of the measuring device due to overvoltage

- Only use measuring devices with a DC input voltage range of 1000 V or higher.

NOTICE**Damage to the DC connectors due to the use of contact cleaner of other cleaning agents**

Some contact cleaners or other cleaning agents may contain substances that decompose the plastic of the DC connectors.

- Do not use contact cleaners or other cleaning agents for cleaning the DC connectors.

Procedure:

1. Ensure that the circuit breaker is switched off from all three line conductors and that it cannot be reconnected.
2. Ensure that there is no ground fault in the PV array.
3. Check whether the DC connectors have the correct polarity.

If the DC connector is equipped with a DC cable of the wrong polarity, the DC connector must be configured again. The DC cable must always have the same polarity as the DC connector.

4. Ensure that the open-circuit voltage of the PV array does not exceed the maximum input voltage of the inverter.
5. Connect the assembled DC connectors to the inverter.
 - The DC connectors snap into place.

6. **NOTICE****Damage to the inverter due to moisture ingress**

The inverter is only properly sealed when all unused DC inputs are closed with DC connectors and sealing plugs.

- Do not insert the sealing plugs directly into the DC inputs on the inverter.
- For unused DC connectors, push down the clamping bracket and push the swivel nut up to the thread.

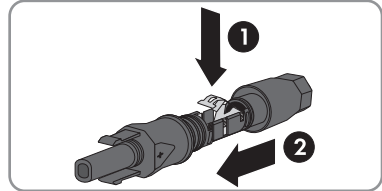

- Insert the sealing plug into the DC connector.

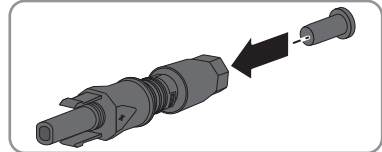

- Tighten the DC connector (torque: 2 Nm).

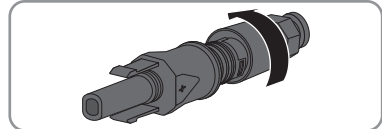

- Insert the DC connectors with sealing plugs into the corresponding DC inputs on the inverter.

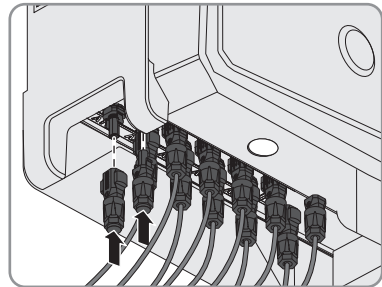

- ☑ The DC connectors snap into place.
- Ensure that all DC connectors are securely in place.

7 Commissioning

7.1 Commissioning Procedure

Before you can commission the inverter, you must check various settings and make changes if necessary. This section describes the procedure and gives an overview of the steps, which must always be performed in the prescribed sequence.

Procedure	See
1. Connection to the SMA Speedwire/Webconnect data module	Installation manual of the SMA Speedwire/Webconnect data module
2. Check which country data set the inverter is set to.	Supplementary sheet with the default settings, type label or display
3. If the country data set is not set correctly for your country or your purpose, adjust to the required country data set.	Section 7.2, page 31
4. Commission the inverter.	Section 7.3, page 32

7.2 Configuring the Country Data Set

Set the country data set appropriate for your country or purpose within the first ten feed-in hours via the rotary switches in the inverter. After the first ten feed-in hours, the country data set can only be changed by means of a communication product.

i The country data set must be set correctly.

If you select a country data set which is not valid for your country and purpose, it can cause a disturbance in the PV system and lead to problems with the grid operator. When selecting the country data set, you must always observe the locally applicable standards and directives as well as the properties of the PV system (e.g. PV system size, grid-connection point).

- If you are not sure which country data set is valid for your country or purpose, contact your grid operator for information on which country data set is to be configured.

i Country data set for operation with external decoupling protection

When operating the PV system with external decoupling protection, the inverter has the additional country data set **Medium-Voltage Directive (Germany)** or **MVtgDirective**. This country data set allows you to extend the operating range of the inverter for voltage and frequency. This country data set should only be selected if the PV system is disconnected via external decoupling.

- If the country data set for operation is set with external decoupling protection, only operate the inverter with an external three-phase decoupling protection. Without external three-phase decoupling protection, the inverter will not disconnect from the utility grid when the country-specific standard requirement is exceeded.

Procedure:

1. Determine the rotary switch position for your country and purpose. Call up the Technical Information "Overview of the Rotary Switch Settings" at www.SMA-Solar.com.

2. **⚠ DANGER**

Danger to life due to high voltages

- Ensure that the inverter is disconnected from all voltage sources and that the enclosure lid is removed (see Section 10, page 43).

3. Set the rotary switches **A** and **B** to the required position using a flat-blade screwdriver (blade width: 2.5 mm).

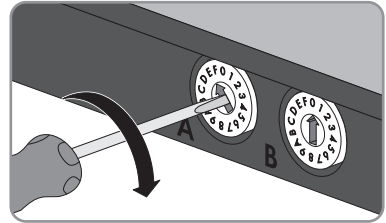

- The inverter will adopt the setting after commissioning. This can take up to five minutes.

7.3 Commissioning the Inverter

Requirements:

- The inverter must be correctly mounted.
- The circuit breaker must be correctly rated and mounted.
- All cables must be correctly connected.
- Unused DC inputs must be sealed using the corresponding DC connectors and sealing plugs.
- The country data set must be set correctly for the country or the purpose.
- Unused enclosure openings must be sealed tightly. The factory-mounted filler plugs can be used for that purpose.

Procedure:

1. Make sure that the AC cable is routed so that it cannot be damaged by the partition in the lower enclosure lid.
2. Insert the lower enclosure lid from above and flip it down. The screws must protrude from the lower enclosure lid.

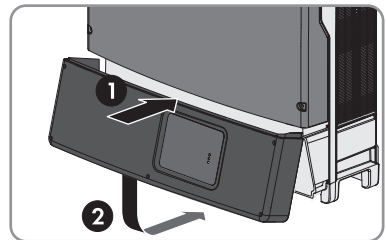

3. Tighten all six screws with an Allen key (AF 3) in the order 1 to 6 (torque: $2.0 \text{ Nm} \pm 0.3 \text{ Nm}$). By tightening the screws in the prescribed order, you avoid warping the enclosure lid, which would keep it from sealing correctly. Useful hint: If the screws fall out of the lower enclosure lid, insert the long screw into the lower middle hole and the five short screws into the other holes.
4. Set the DC load-break switch to position **O** so that both mounting screws are visible.

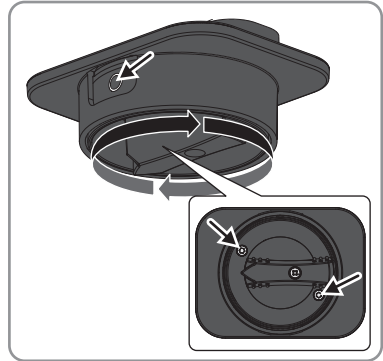
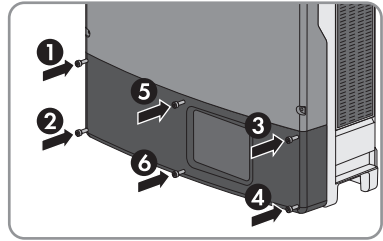

5. Insert the DC load-break switch firmly into the recess on the inverter. During this process, the DC load-break switch must still be in position **O** and aligned so that the screws are positioned over the threads.
6. Fasten the two screws using an Allen key (AF 3) (torque: $2 \text{ Nm} \pm 0.2 \text{ Nm}$).

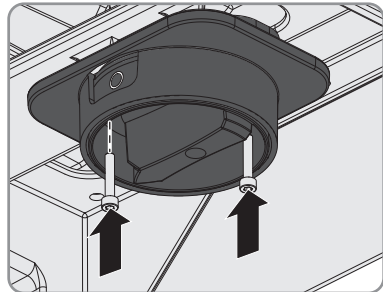

7. Turn the DC load-break switch to the position I.

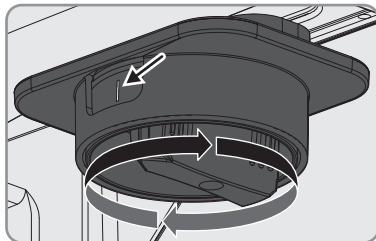

8. Switch on the circuit breaker of all three line conductors.

- All three LEDs start to glow and the start-up phase begins. The start-up phase may take several minutes.
- The green LED is glowing. Feed-in operation begins.
- The green LED is flashing?

Possible cause of error: the DC input voltage is still too low or the inverter is monitoring the utility grid.

- Once the DC input voltage is sufficiently high and the grid-connection conditions are met, the inverter will start operation.
- The red LED is glowing?
 - Rectify the error (see the service manual at www.SMA-Solar.com).

8 Configuration

8.1 Configuration Procedure

Once you have commissioned the inverter, you may have to adjust various settings via the rotary switches in the inverter or via a communication product. This section describes the procedure for configuration and gives an overview of the steps you must perform in the prescribed order.

Procedure	See
1. If required, integrate the inverter in a Speedwire network.	Section 8.2, page 35
2. To manage the PV system data or to set the inverter parameters, capture the inverter in a communication product.	Manual of the communication product at www.SMA-Solar.com
3. Change the system time and system password.	Manual of the communication product at www.SMA-Solar.com
4. If required, register the inverter in Sunny Portal.	Manual of the SMA Speedwire/Web-connect data module
5. Set the active power limitation in case of PV system control failure.	Section 8.4, page 36
6. If required, reduce the attenuation of ripple control signals.	Section 8.6, page 37
7. For partially shaded PV modules and depending on the given shading situation, you should set the interval at which the inverter optimizes the MPP of the PV system.	Section 8.7, page 38

8.2 Integrating the Inverter into the Network

If the router supports DHCP and DHCP is enabled, the inverter will automatically be integrated into the network. You will not need to carry out network configuration.

If the router does not support DHCP, automatic network configuration will not be possible and you will need to use the SMA Connection Assist to integrate the inverter into the network.

Requirements:

- The inverter must be in operation.
- There must be a router with Internet connection in the local network of the system.
- The inverter must be connected to the router.

Procedure:

- Integrate the inverter into the network by means of the SMA Connection Assist. Download the SMA Connection Assist and install it on the computer (see www.SMA-Solar.com).

8.3 Changing Operating Parameters

This section describes the basic procedure for changing operating parameters. Always change operating parameters as described in this section. Some parameters that have sensitive functions can only be viewed and changed by qualified persons (for further information on changing parameters, refer to the manual of the communication product).

The operating parameters of the inverter are set to certain values by default. To optimize inverter operation, you can change the operating parameters using a communication product.

Requirements:

- Depending on the type of communication, a computer with Ethernet interface must be available.
- A communication product corresponding to the type of communication used must be available.
- The inverter must be registered in the communication product.
- The changes to the grid-relevant parameters must be approved by the responsible grid operator.
- When changing grid-relevant parameters, the SMA Grid Guard code must be available (see "Application for SMA Grid Guard Code" at www.SMA-Solar.com).

Procedure:

1. Call up the user interface of the communication product or software and log in as **Installer** or **User**.
2. If required, enter the SMA Grid Guard code.
3. Select and set the required parameter.
4. Save settings.

8.4 Setting the Active Power Limitation in case of PV System Control Failure

You will need to set the active power limitation in case of PV system control failure if the active power limitation of the inverter is controlled by a communication product. By setting the active power limitation in case of PV system control failure, you ensure that the inverter will still feed the maximum permissible PV power into the utility grid, even if communication between inverter and communication product has failed. The default setting of the inverter is 100%.

The basic procedure for changing operating parameters is explained in another section (see Section 8.3 "Changing Operating Parameters", page 36).

Requirements:

- The parameter **Operating mode Active power** must be set to the value **Act. power lim. via PV system ctrl.**
- The firmware version of the inverter must be at least 2.81.07.R.
- The total installed PV power must be known.

- The active power feed-in specified by the grid operator must be known.

Procedure:

1. Ensure that the firmware version of the inverter is at least 2.81.07.R. If necessary, carry out a firmware update.
2. Select the parameter **Fallback act power lmt P in % of WMax for absent act power lmt** and set the required percentage.
3. Select the parameter **Operating mode for absent plant control** and set to **Use fallback setting**.

8.5 Configuring the Modbus Function

The Modbus interface is deactivated by default and the communication ports **502** set. In order to access SMA inverters with SMA Modbus® or SunSpec® Modbus®, the Modbus interface must be activated. After activating the interface, the communication ports of both IP protocols can be changed.

For information on commissioning and configuration of the Modbus interface, see the Technical Information "SMA Modbus® Interface" or in the Technical Information "SunSpec® Modbus® Interface" at www.SMA-Solar.com.

Data security during activated Modbus interface

If you activate the Modbus interface, there is a risk that unauthorized users may access and manipulate the data or devices in your PV system.

- Take appropriate protective measures such as:
 - Set up a firewall.
 - Close unnecessary network ports.
 - Only enable remote access via VPN tunnel.
 - Do not set up port forwarding at the communication port in use.
 - In order to deactivate the Modbus interface, reset the inverter to default settings.

Procedure:

- Activate the Modbus interface and adjust the communication ports if necessary (see the Technical Information "SMA Modbus® Interface" or "SunSpec® Modbus® Interface" at www.SMA-Solar.com).

8.6 Reducing the Attenuation of Ripple Control Signals

By setting certain parameters, the attenuation of three-phase parallel ripple control frequencies ranging from 1,000 Hz to 1,100 Hz can be avoided. The parameters must only be set in consultation with the responsible grid operator.

The basic procedure for changing operating parameters is explained in another section (see Section 8.3 "Changing Operating Parameters", page 36).

Requirement:

- The firmware version of the inverter must be at least 2.81.07.R.

Procedure:

- Set the following parameters:

Parameter name for RS485	Parameter name for BLUE-TOOTH or Speedwire/Webconnect	Unit	Range	Value to be set
RplDet-NBS-Gain	Ripple control signal detection, amplification of narrow-band backup	V/A	0 to -10	-9
RplDet-NBS-Damp	Ripple control signal detection, attenuation of narrow-band backup	p.u.	-	0.1
RplDet-NBS-Hz	Ripple control signal detection, frequency of the narrow-band backup	Hz	1,000 to 1,100	Must be specified by the grid operator

8.7 Setting SMA OptiTrac Global Peak

For partially shaded PV modules, you should set the interval at which the inverter is to optimize the MPP of the PV system. If you do not want to use SMA OptiTrac Global Peak feature, you can deactivate the feature.

The basic procedure for changing operating parameters is explained in another section (see Section 8.3 "Changing Operating Parameters", page 36).

Procedure:

- Select the parameter **Cycle time of the OptiTrac Global Peak algorithm** or **MPPShdw.CycTms** and set the required time interval. The ideal time interval is usually six minutes. This value should only be increased if the shading situation changes extremely slowly.
 - The inverter optimizes the MPP of the PV system at the predetermined time interval.
- In order to deactivate the SMA OptiTrac Global Peak feature, select the parameter **OptiTrac Global Peak switched on** or set **MPPShdw.IsOn** to **Off**.

9 Operation

9.1 LED Signals

The LEDs indicate the operating state of the inverter.

LED	Status	Explanation
Green LED	glowing	Feed-in operation If an event occurs during feed-in operation, an event message will be shown in the communication product (for event messages see the service manual at www.SMA-Solar.com).
	flashing	The conditions for feed-in operation are not yet met. As soon as the conditions are met, the inverter will start feed-in operation.
Red LED	glowing	Error An error has occurred. The error must be rectified by a qualified person (for troubleshooting, see the service manual at www.SMA-Solar.com).
Blue LED	-	No function

9.2 Display Overview

The display shows the current operating data of the inverter (e.g. current power, daily energy, total energy) as well as events or errors. Power and energy are displayed as bars in a diagram.

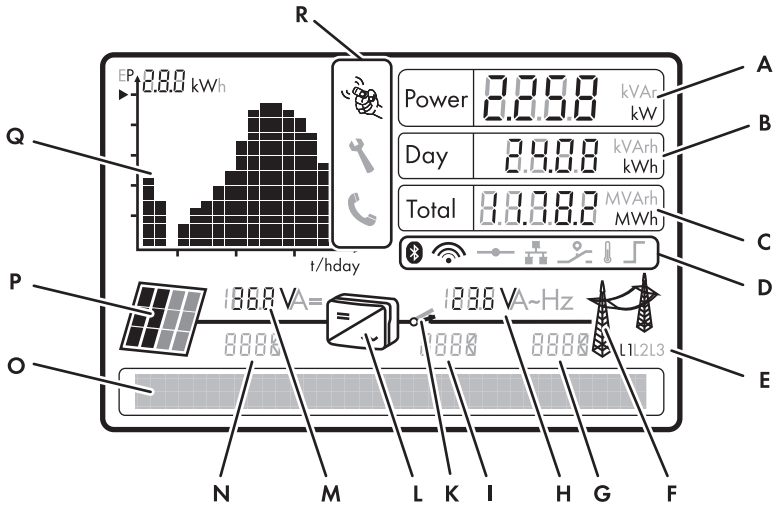













Figure 8: Display overview (example)

Position	Symbol	Explanation
A	-	Current power
B	-	Energy on the current day
C	-	Total amount of energy fed in
D		Active connection to a Speedwire network
		Active connection to Sunny Portal
		Multifunction relay is active
		Power limitation due to excessive temperature
		Active power limitation via PV system control
E	-	When output voltage is displayed: line conductors between which the output voltage is present When output current is displayed: line conductor to which the output current is allocated
F		Utility grid

Position	Symbol	Explanation
G	-	Event number of an error on the utility grid side
H	-	Output voltage or output current of the respective line conductor
I	-	Event number of an error in the inverter
K		Grid relay When the grid relay is closed, the inverter feeds into the utility grid. When the grid relay is open, the inverter is disconnected from the utility grid.
L		Inverter
M	-	Input voltage or input current of the respective line conductor
N	-	Event number of an error on the PV array side
O	-	Text line to display event and error messages
P	-	PV array
Q	-	Diagram with the power curve of the last 16 feed-in hours or energy yields of the last 16 days <ul style="list-style-type: none"> In order to switch between diagrams, tap once on the enclosure lid.
R		You can operate the display by tapping on the enclosure lid.
		The displayed error must be rectified on-site by a qualified person.
		The displayed error cannot be rectified on-site. <ul style="list-style-type: none"> Contact the Service.

9.3 Activating and Operating the Display

You can activate and operate the display by tapping on the enclosure lid.

Procedure:

1. Activate the display. Tap on the enclosure lid once.
 - The backlight is switched on.
2. To move to the next line, tap on the enclosure lid once.
3. In order to switch between the power curve of the last 16 feed-in hours and the energy yields of the last 16 days in the diagram, tap on the enclosure lid once.

9.4 Calling Up Display Messages of the Start-Up Phase

Various inverter information is displayed during the start-up phase that can be called up whenever required during operation.

Procedure:

- Tap on the enclosure lid twice.
 - The display shows all messages of the start-up phase in sequence.

10 Disconnecting the Inverter from Voltage Sources

Prior to performing any work on the inverter, always disconnect it from all voltage sources as described in this section. Always adhere to the prescribed sequence.

NOTICE

Damage to seals on the enclosure lids in subfreezing conditions

If you open the upper and lower enclosure lids when temperatures are below freezing, the enclosure seals can be damaged. This can lead to moisture entering the inverter.

- Do not open the inverter at ambient temperatures lower than -5°C .
- If a layer of ice has formed on the seal of the lid when temperatures are below freezing, remove it prior to opening the enclosure lids of the inverter (e.g. by melting the ice with warm air). Observe the applicable safety regulations.

NOTICE

Destruction of the measuring device due to overvoltage

- Only use measuring devices with a DC input voltage range of 1000 V or higher.

Procedure:

1. Disconnect the circuit breaker from all three line conductors and secure it against reconnection.
2. Turn the DC load-break switch to the position **O**.

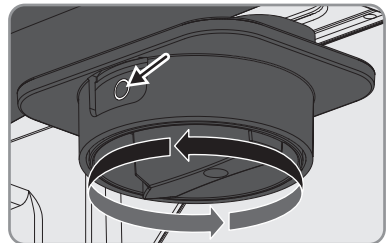

3. If the multifunction relay is used, switch off any supply voltage to the load.
4. Wait until the LEDs have gone out and, if necessary, the load connected to the multifunction relay has been switched off.
5. Use a current clamp to ensure that no current is present in the DC cables.

6. Unscrew the two screws on the DC load-break switch using an Allen key (AF 3).

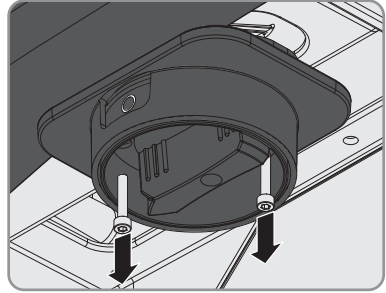

7. Pull the DC load-break switch down and out of the recess.

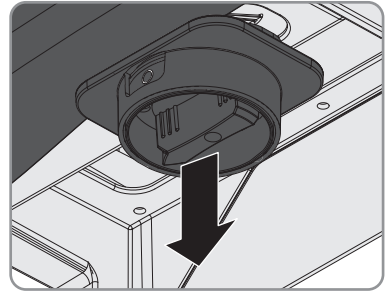

8. Remove all six screws from the lower enclosure lid using an Allen key (AF 3).

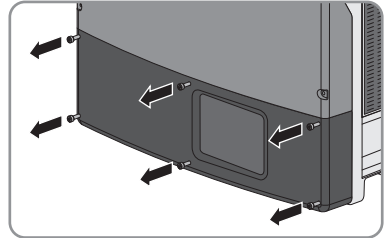

9. Lift and remove the lower enclosure lid from below.

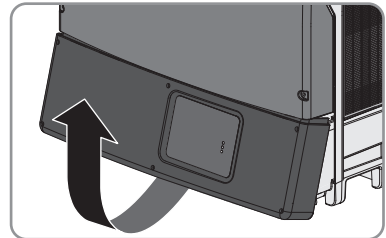

10. **⚠ CAUTION**

Risk of burns when touching the DC protective cover

The DC protective cover can get hot during operation.

- Do not touch the DC protective cover.

11. Release and remove all DC connectors. Insert a slotted screwdriver or an angled screwdriver (blade width 3.5 mm) into one of the slide slots and pull the DC connectors out downwards. Do not pull on the cable.

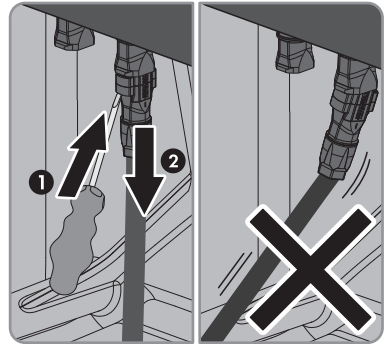

12. Ensure that no voltage is present at the DC inputs of the inverter.
13. Use an appropriate measuring device to ensure that no voltage is present at the AC connecting terminal plate between **L1** and **N**, **L2** and **N**, and **L3** and **N**. Insert the test probe of the multimeter into the round opening of the terminal.

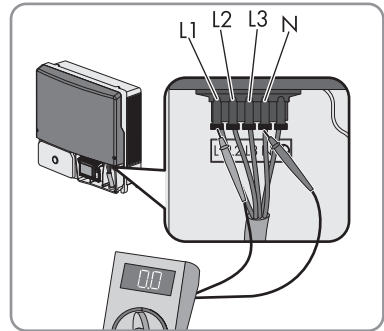

14. Use an appropriate measuring device to ensure that no voltage is present at the AC connecting terminal plate between **L1** and **PE**, **L2** and **PE**, and **L3** and **PE**. Insert the test probe into the round opening of each terminal.
15. Ensure that no voltage is present between any terminal of the multifunction relay and **PE** of the AC connecting terminal plate.
16. **⚠ DANGER**

Danger to life due to high voltages in the inverter

The capacitors in the inverter take 20 minutes to discharge.

- Wait 20 minutes before opening the upper enclosure lid.
- Do not open the DC protective cover.

17. **NOTICE**

Damage to the inverter due to electrostatic discharge

Touching electronic components can cause damage to or destroy the inverter through electrostatic discharge.

- Ground yourself before touching any component.

11 Technical Data

DC Input

	STP 15000TL-30	STP 20000TL-30	STP 25000TL-30
Maximum DC power at $\cos \varphi = 1$	15330 W	20440 W	25550 W
Maximum input voltage	1000 V	1000 V	1000 V
MPP voltage range	240V to 800 V	320 V to 800 V	390 V to 800 V
Rated input voltage	600 V	600 V	600 V
Minimum usable input voltage	150 V	150 V	150 V
Initial input voltage	188 V	188 V	188 V
Maximum input current, input A	33 A	33 A	33 A
Maximum input current, input B	33 A	33 A	33 A
Maximum short-circuit current per string*	43 A	43 A	43 A
Maximum reverse current in the system for max. 1 ms	0 A	0 A	0 A
Number of independent MPP inputs	2	2	2
Strings per MPP input	3	3	3
Overvoltage category in accordance with IEC 62109-1	II	II	II

* In accordance with IEC 62109-2: $I_{SC PV}$

AC Output

	STP 15000TL-30	STP 20000TL-30	STP 25000TL-30
Rated power at 230 V, 50 Hz	15000 W	20000 W	25000 W
Maximum apparent AC power	15000 VA	20000 VA	25000 VA
Rated grid voltage	230 V	230 V	230 V
Nominal AC voltage	220 V / 230 V / 240 V	220 V / 230 V / 240 V	220 V / 230 V / 240 V
AC voltage range*	180 V to 280 V	180 V to 280 V	180 V to 280 V
Nominal AC current at 230 V	21.7 A	29 A	36.2 A
Maximum output current	29 A	29 A	36.2 A
Maximum output current under fault conditions	50 A	50 A	50 A

	STP 15000TL-30	STP 20000TL-30	STP 25000TL-30
Total harmonic distortion of the output current with total harmonic distortion of the AC voltage < 2%, and AC power > 50% of the rated power	≤3 %	≤3 %	≤3 %
Rated power frequency	50 Hz	50 Hz	50 Hz
AC power frequency*	50 Hz / 60 Hz	50 Hz / 60 Hz	50 Hz / 60 Hz
Operating range at AC power frequency 50 Hz	44 Hz to 55 Hz	44 Hz to 55 Hz	44 Hz to 55 Hz
Operating range at AC power frequency 60 Hz	54 Hz to 65 Hz	54 Hz to 65 Hz	54 Hz to 65 Hz
Power factor at rated power	1	1	1
Displacement power factor, adjustable	0 _{overexcited} to 0 _{underexcited}	0 _{overexcited} to 0 _{underexcited}	0 _{overexcited} to 0 _{underexcited}
Feed-in phases	3	3	3
Phase connection	3	3	3
Overvoltage category in accordance with IEC 62109-1	III	III	III

* depending on the configured country data set

Efficiency

	STP 15000TL-30	STP 20000TL-30	STP 25000TL-30
Maximum efficiency, η_{\max}	98.4 %	98.4 %	98.3 %
European weighted efficiency, η_{EU}	98.0 %	98.0 %	98.1 %

Protective Devices

DC reverse polarity protection	Short-circuit diode
Input-side disconnection point	DC load-break switch
DC overvoltage protection	Surge arrester type II (optional)
AC short-circuit current capability	Current control
Grid monitoring	SMA Grid Guard 3
Maximum permissible fuse protection	50 A
Ground fault monitoring	Insulation monitoring: $R_{\text{iso}} > 250 \text{ k}\Omega$
All-pole sensitive residual-current monitoring unit	Available

General Data

Width x height x depth, with DC load-break switch plugged in	661 mm x 682 mm x 264 mm
Weight	61 kg
Length x width x height of the packaging	780 mm x 380 mm x 790 mm
Transport weight	68 kg
Climatic category in accordance with IEC 60721-3-4	4K4H
Environmental category	Outdoors
Pollution degree outside the enclosure	3
Pollution degree inside the enclosure	2
Operating temperature range	-25 °C to +60 °C
Maximum permissible value for relative humidity, non-condensing	100 %
Maximum operating altitude above mean sea level (MSL)	3000 m
Typical noise emission	51 dB(A)
Power loss in night mode	1 W
Topology	Transformerless
Cooling method	SMA OptiCool
Degree of protection for electronics in accordance with IEC 60529	IP65
Protection class in accordance with IEC 62109-1	I

Grid configurations	TN-C, TN-S, TN-C-S, TT (when $V_{N,PE} < 20 \text{ V}$)
National standards and approvals, as per 08/2016*	ANRE 30, AS 4777.2:2015, AS 4777.3, BDEW 2008, C10/11:2012, CE, CEI 0-16, CEI 0-21, EN 50438:2013, G59/3, IEC 60068-2-x, IEC 61727, IEC 62109-1/2, IEC 62116, MEA 2013, NBR 16149, NEN EN 50438, NRS 097-2-1, PEA 2013, PPC, RD 1699/413, RD 661/2007, Res. n°7:2013, SI 4777, TOR D4, TR 3.2.2, UTE C15-712-1, VDE 0126-1-1, VDE-AR-N 4105, VFR 2014

* **EN 50438:2013** Does not apply to all country standard deviations of EN 50438

IEC 62109-2: In order to meet the requirements of this standard, the inverter must either be equipped with a multifunction relay used as a fault indicator contact or there must be a connection to Sunny Portal with the fault alarm in Sunny Portal activated.

NRS 97-1-2: This standard requires a separate label attached to the AC distribution board which indicates the AC-side disconnection of the inverter in case of a grid failure (for further details, see NRS 97-1-2, Sect. 4.2.7.1 and 4.2.7.2).

RD 1699 and RD 661/2007: Contact the Service for restrictions in specific regions.

Climatic Conditions

Installation in accordance with IEC 60721-3-4, Class 4K4H

Extended temperature range	-25 °C to +60 °C
Extended humidity range	0% to 100%
Threshold for relative humidity, non-condensing	100 %
Extended air pressure range	79.5 kPa to 106 kPa

Transport in accordance with IEC 60721-3-4, Class 2K3

Temperature range	-25 °C to +70 °C
-------------------	------------------

Equipment

DC connection	SUNCLIX DC connector
AC connection	Spring-cage terminal
Speedwire/Webconnect data module	As standard
RS485, galvanically isolated	Optional
Multifunction relay	Optional
SMA Power Control Module	Optional
Surge arrester type II	Optional

Fans

Width x height x depth	60 mm x 60 mm x 25.4 mm
Noise emission, typical	≤ 29 dB(A)
Maximum operating altitude	3000 m
Air flow rate	≥ 40 m ³ /h

Torques

Upper lid screws	6 Nm ± 0.3 Nm
Screws lower lid	2 Nm ± 0.3 Nm
Screws for DC protective cover	3.5 Nm
Screw for additional grounding	5.8 Nm
SUNCLIX swivel nut	2 Nm

Data Storage Capacity

Daily energy yields	63 days
Daily yields	30 years
Event messages for users	250 events
Event messages for installers	250 events

12 Accessories

You will find the accessories for your product in the following overview. If required, these can be ordered from SMA Solar Technology AG or your distributor.

Designation	Short description	SMA order number
RS485 data module	RS458 interface as retrofit kit	DM-485CB-10
SMA Power Control Module	Multifunction interface for implementing grid management systems for one inverter	PWCMOD-10
Multifunction Relay	Multifunction relay as retrofit kit	MFR01-10
Type II surge arrester	Type II surge arrester for input A and input B	DC_SPD_KIT3-10

13 Contact

If you have technical problems with our products, please contact the SMA Service Line. We require the following information in order to provide you with the necessary assistance:

- Inverter device type
- Inverter serial number
- Inverter firmware version
- Special country-specific settings of the inverter (if applicable)
- Type and number of PV modules connected
- Mounting location and altitude of the inverter
- Inverter message
- Optional equipment, e.g. communication products
- If necessary, system name in the Sunny Portal
- If necessary, access data in the Sunny Portal
- Operating mode of the multifunction relay (if present)

Danmark	SMA Solar Technology AG	Belgien	SMA Benelux BVBA/SPRL
Deutschland	Niestetal	Belgique	Mechelen
Österreich	SMA Online Service Center:	België	+32 15 286 730
Schweiz	www.SMA-Service.com	Luxemburg	
	Sunny Boy, Sunny Mini Central, Sunny Tripower: +49 561 9522-1499	Luxembourg	
	Monitoring Systems (Kommunikationsprodukte): +49 561 9522-2499	Nederland	
	Fuel Save Controller (PV-Diesel-Hybridssysteme): +49 561 9522-3199	Česko	SMA Service Partner TERMS a.s.
	Sunny Island, Sunny Boy Storage, Sunny Backup, Hydro Boy: +49 561 9522-399	Magyarország	+420 387 6 85 111
	Sunny Central: +49 561 9522-299	Slovensko	
France	SMA France S.A.S. Lyon +33 472 22 97 00	Polska	SMA Polska +48 12 283 06 66
		Ελλάδα	SMA Hellas AE
		Κύπρος	Αθήνα +30 210 9856666

España Portugal	SMA Ibérica Tecnología Solar, S.L.U. Barcelona +34 935 63 50 99	United King- dom	SMA Solar UK Ltd. Milton Keynes +44 1908 304899
Bulgaria Italia România	SMA Italia S.r.l. Milano +39 02 8934-7299		
United Arab Emirates	SMA Middle East LLC Abu Dhabi +971 2234 6177	India	SMA Solar India Pvt. Ltd. Mumbai +91 22 61713888
ไทย	SMA Solar (Thailand) Co., Ltd. กรุงเทพฯ +66 2 670 6999	대한민국	SMA Technology Korea Co., Ltd. 서울 +82-2-520-2666
South Africa	SMA Solar Technology South Africa Pty Ltd. Cape Town 08600SUNNY (08600 78669) International: +27 (0)21 826 0600	Argentina Brasil Chile Perú	SMA South America SPA Santiago +562 2820 2101
Australia	SMA Australia Pty Ltd. Sydney Toll free for Australia: 1800 SMA AUS (1800 762 287) International: +61 2 9491 4200	Other countries	International SMA Service Line Niestetal 00800 SMA SERVICE (+800 762 7378423)

14 EU Declaration of Conformity

within the scope of the EU directives

- Electromagnetic compatibility 2014/30/EU (L 96/79-106, March 29, 2014) (EMC)
- Low Voltage Directive 2014/35/EU (L 96/357-374, March 29, 2014) (LVD)



SMA Solar Technology AG confirms herewith that the inverters described in this document are in compliance with the fundamental requirements and other relevant provisions of the above-mentioned directives. The entire EU Declaration of Conformity can be found at www.SMA-Solar.com.

